

Instructions

Model: SL3W-XX-YY

XX refers to colour temperature:
WW (3000K) or NW (4000K)

YY refers to finish colour:
B (Black), BN (Brushed Nickel), W (White)

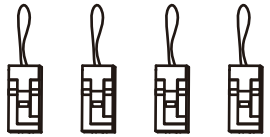
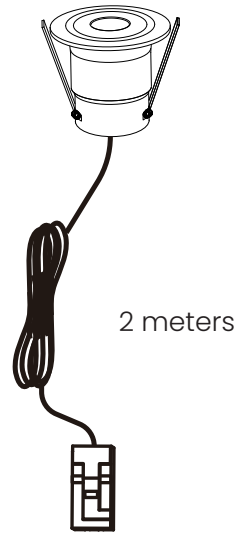

4x Plugs

Dimmable LED Driver

Junction Box

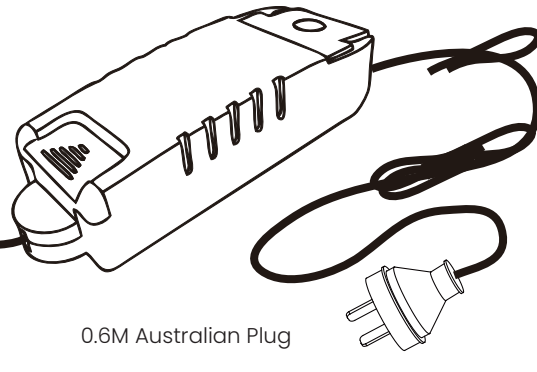
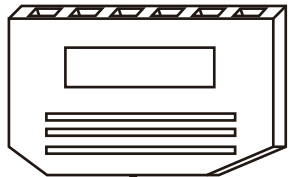

0.6M Australian Plug

Instructions(continued)

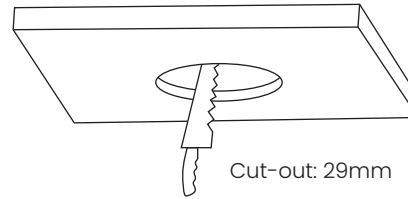

Cut-out: 29mm

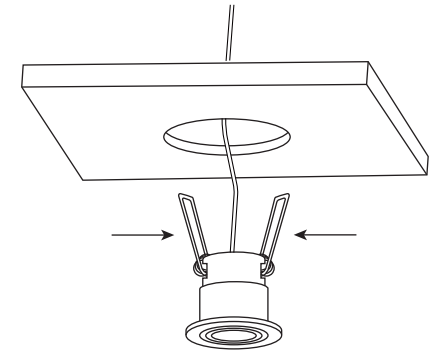

AC Input

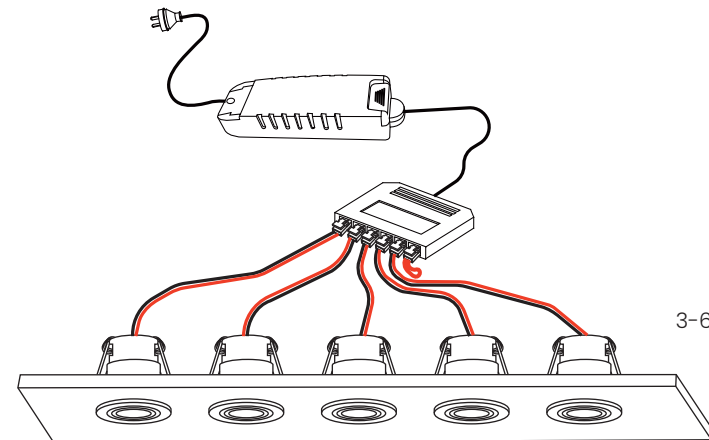

3-6PCS