

INSTALLATION MANUAL

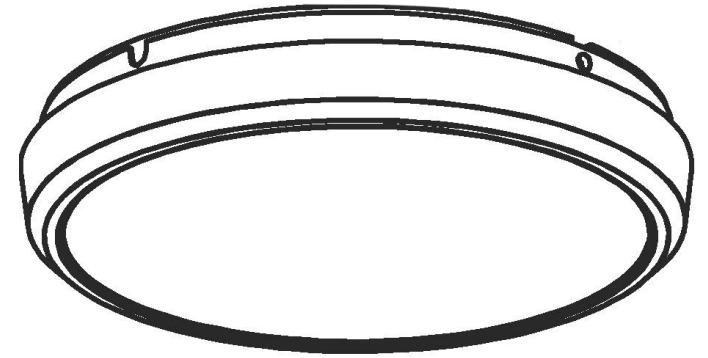

LED

OYSTER LIGHT

O18W

Wiring Diagram

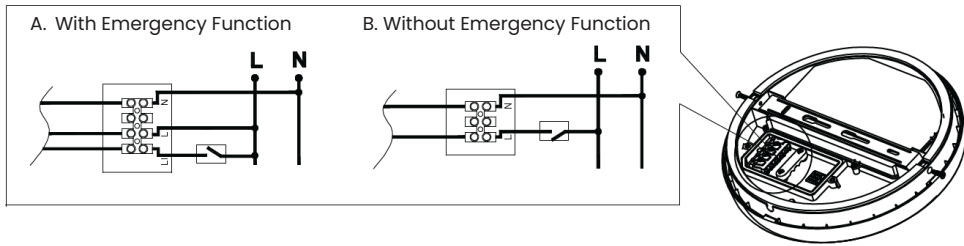

Installation Steps

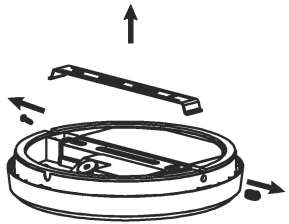

Fig 1. Remove the mounting bracket by almost completely loosening the screws on both sides of the casing.

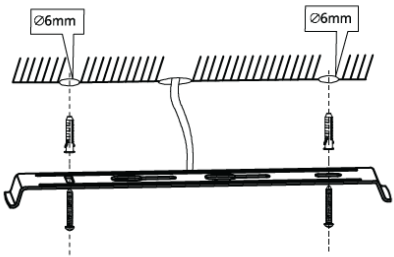

Fig 2. Fix the mounting bracket to the wall/ ceiling.

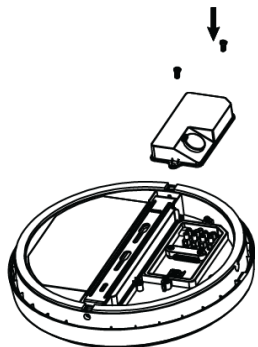

Fig 3. Remove the cover of the terminal compartment (it's the smaller compartment).

Installation Steps (continued)

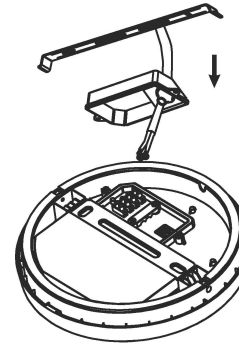

Fig 4. Thread the AC mains cable through the rubber grommet and connect the wires to the terminal block .

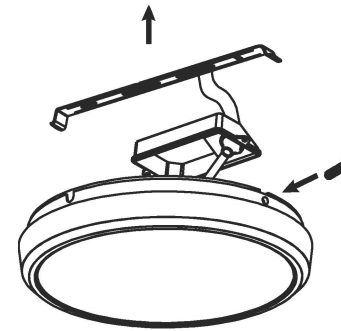

Fig 5. Reinstall the terminal cover, mount the fixture onto the installed bracket and tighten the loosened screws.

Parts Included



Necessary Tools

