

Indoor Luminaire Photometric Data

Description Information

Lum. Name: B40W-CC-MS-E 6K	Lum. Catalog: LEDE BATTEN	Test ID:
Lamp Name: 6000K	Lamp Catalog: SMD2835	Test Date: 2018/11/01
Manufacture:	ShldAngle(°):	Test Machine: GON-2000
Test Lab:	Frequency (Hz):	Lamp CCT (K): Ra:
Lum. Size (W*L*H): 0.080m*1.200m*0.065m	Lum. Area (m2): 0.174	Lum. W (kg): 2.000
Test System: C, γ	Test Step: C=90.0 γ=5.0	Temp. (°C): 25
		Humidity (%):

Character Parameter

Lamp Speciality Parameter	Luminaire Speciality Parameter	
Rated Flux (lm): 3551.920	Luminaire Flux: 3551.919lm	Field Angle (10%Imax): 260.3
Rated Power (W):	Luminaire Efficiency: 100.00%	Down Lumens&Percent: 3158.163lm 88.91%
Rated Voltage (V):	Luminaire EER (lm/W): 83.398	Up Lumens&Percent: 393.756lm 11.09%
Tested Power (W): 42.590	Max. Cand. (cd): 977.242	S/MH: C0_a180=1.352 C90_270=1.258
Lamps' Inside: 1	Max Cand@Ang. (°): C=0.0 γ=5.0	CIE Type: General Diffuse
Tested Electric: U=240.4V, I=0.190A, PF=0.000	Beam Angle (50%Imax): 130.3	ErP Φ use (120°): 2325.106lm
Lamp Size (W*L*H): 0.080m*1.200m*0.065m	Left=-65.2 Right=65.1	IRF: 102.627%

Lighting Distribution Diagram

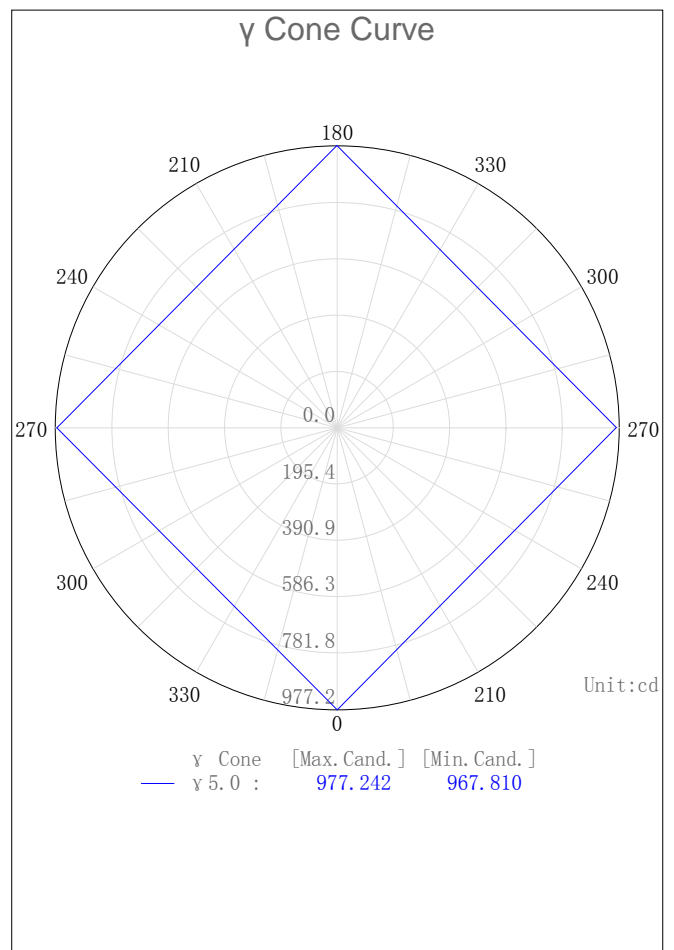
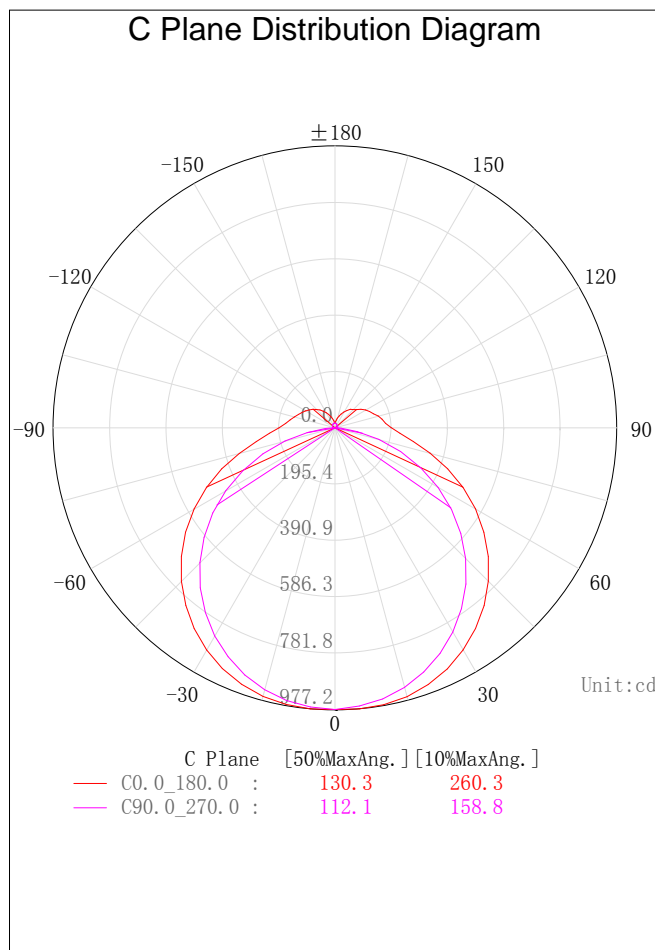

3D Light Intensity Distribution Modal

Lum. Name: B40W-CC-MS-E 6K	Lum. Catalog: LEDE BATTEN	Test ID:
Lamp Name: 6000K	Lamp Catalog: SMD2835	Test Lab:
Manufacture:	Test Machine: GON-2000	Test Date: 2018/11/01

3D Light Intensity Distribution Modal

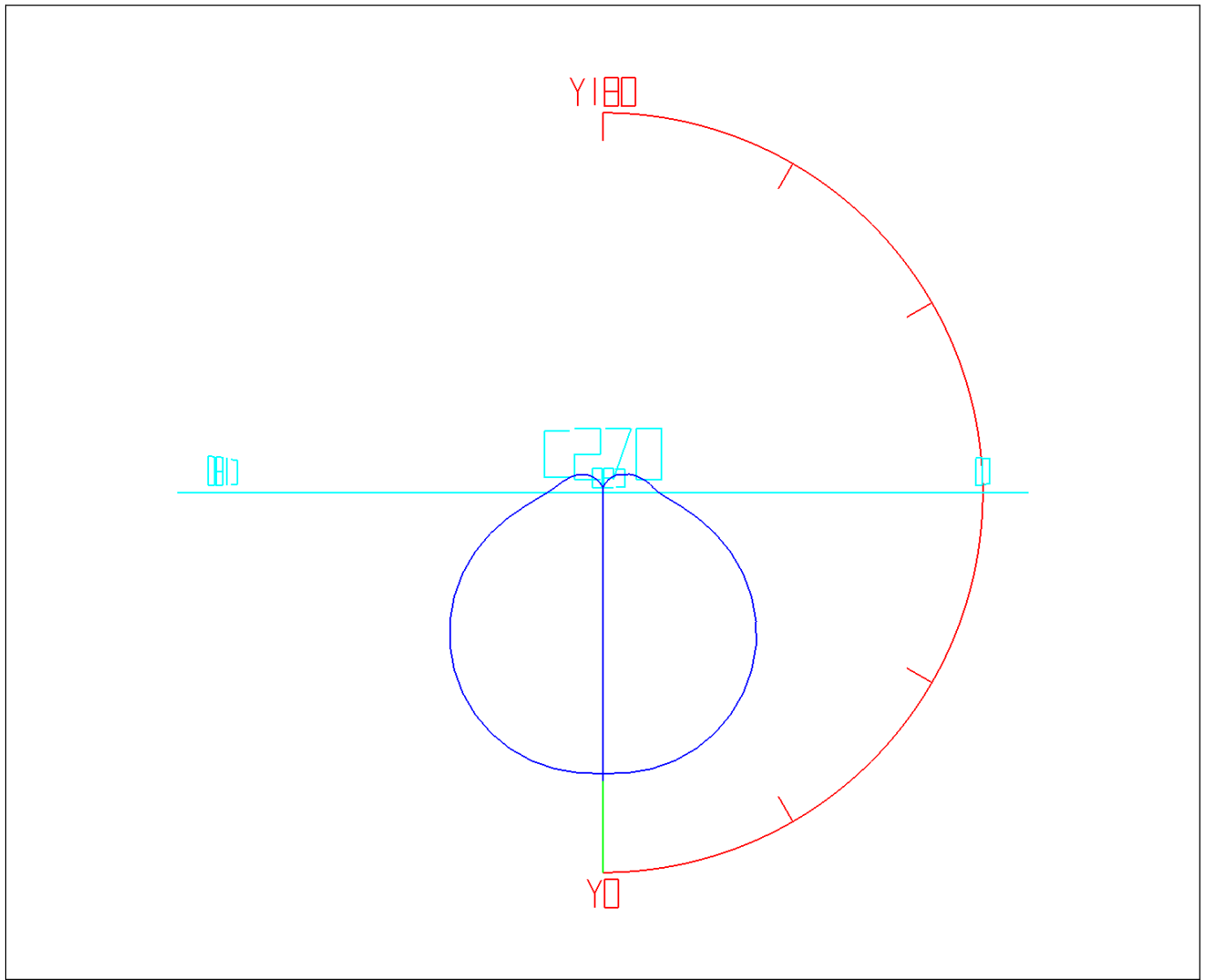

Curves: 3D Model — Fixture — Vert. HUD — Hori. HUD —
 View Angles: Orient:0 Tilt:0 Roll:0 Spin:0

IES Indoor Report

Photometric Filename: B40W-CC-MS-E 6K.IES

Zonal Flux Tabulation

Zone (y)	Zone Flux (lm)	Sums Flux (lm)	Zone%Lamp	Sums%Lamp
0.0-5.0	23.30	23.30	0.66	0.66
5.0-10.0	69.35	92.64	1.95	2.61
10.0-15.0	113.59	206.23	3.20	5.81
15.0-20.0	154.60	360.83	4.35	10.16
20.0-25.0	191.04	551.87	5.38	15.54
25.0-30.0	221.73	773.60	6.24	21.78
30.0-35.0	245.69	1019.28	6.92	28.70
35.0-40.0	262.12	1281.41	7.38	36.08
40.0-45.0	270.51	1551.91	7.62	43.69
45.0-50.0	270.49	1822.40	7.62	51.31
50.0-55.0	261.99	2084.39	7.38	58.68
55.0-60.0	245.29	2329.68	6.91	65.59
60.0-65.0	220.94	2550.62	6.22	71.81
65.0-70.0	190.00	2740.62	5.35	77.16
70.0-75.0	154.25	2894.87	4.34	81.50
75.0-80.0	117.07	3011.94	3.30	84.80
80.0-85.0	84.07	3096.01	2.37	87.16
85.0-90.0	62.16	3158.16	1.75	88.91
90.0-95.0	52.07	3210.23	1.47	90.38
95.0-100.0	47.38	3257.61	1.33	91.71
100.0-105.0	43.69	3301.30	1.23	92.94
105.0-110.0	39.80	3341.10	1.12	94.06
110.0-115.0	35.94	3377.03	1.01	95.08
115.0-120.0	32.34	3409.38	0.91	95.99
120.0-125.0	28.65	3438.02	0.81	96.79
125.0-130.0	24.75	3462.77	0.70	97.49
130.0-135.0	21.08	3483.85	0.59	98.08
135.0-140.0	17.88	3501.74	0.50	98.59
140.0-145.0	14.75	3516.49	0.42	99.00
145.0-150.0	11.59	3528.08	0.33	99.33
150.0-155.0	8.78	3536.86	0.25	99.58
155.0-160.0	6.36	3543.22	0.18	99.76
160.0-165.0	4.30	3547.52	0.12	99.88
165.0-170.0	2.64	3550.16	0.07	99.95
170.0-175.0	1.35	3551.52	0.04	99.99
175.0-180.0	0.40	3551.92	0.01	100.00

Rectangle ISO Lighting Intensity Diagram

Lum. Name: B40W-CC-MS-E 6K	Lum. Catalog: LEDE BATTEN	Test ID:
Lamp Name: 6000K	Lamp Catalog: SMD2835	Test Lab:
Manufacture:	Test Machine: GON-2000	Test Date: 2018/11/01

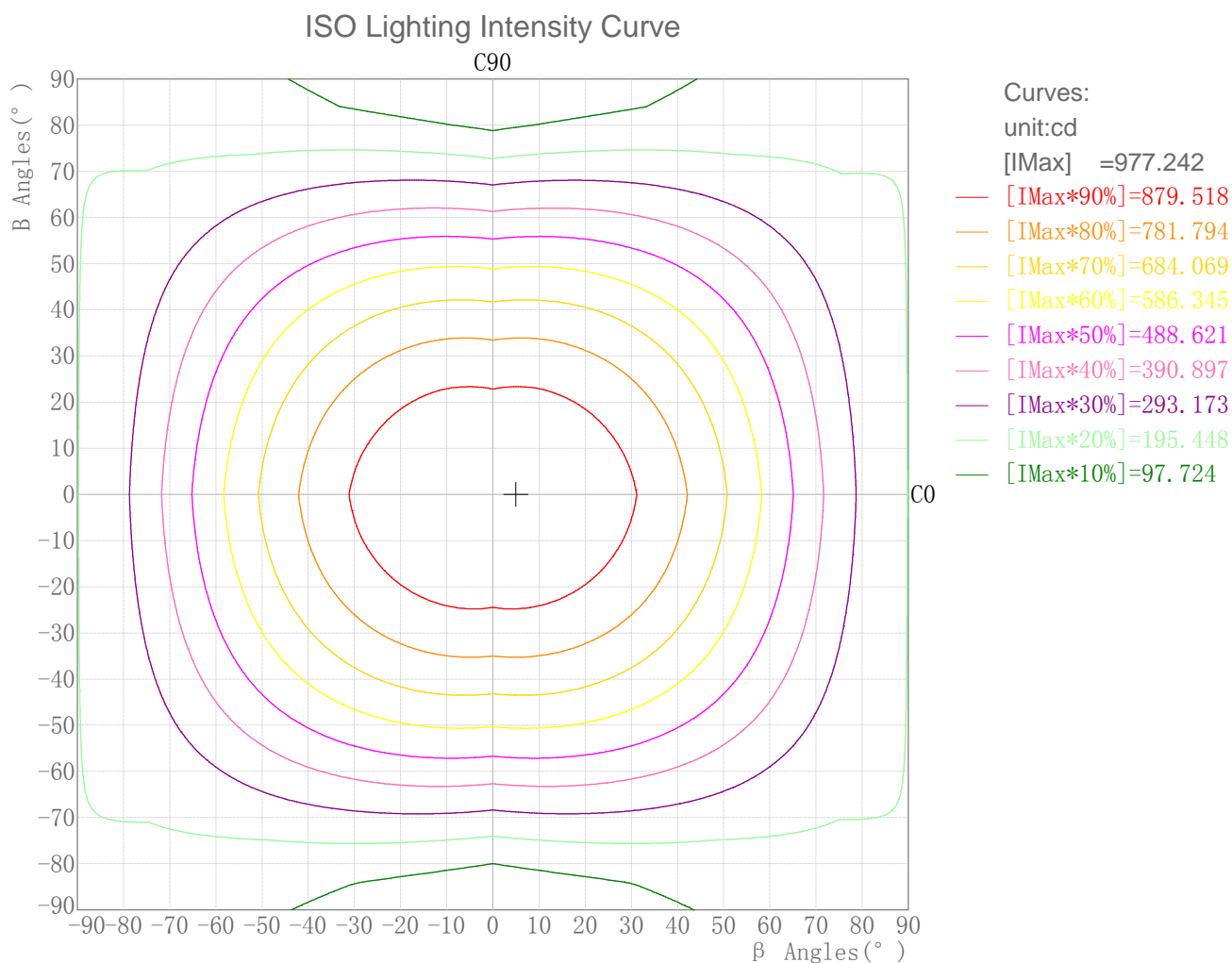

Maximum Light Intensity(cd): 977.24
 Maximum Cand.@Angle: H=5.0°;V=0.0°

Plane ISO-Illuminance Diagram

Lum. Name: B40W-CC-MS-E 6K	Lum. Catalog: LEDE BATTEN	Test ID:
Lamp Name: 6000K	Lamp Catalog: SMD2835	Test Lab:
Manufacture:	Test Machine: GON-2000	Test Date: 2018/11/01

Plane ISO-Illuminance Curve

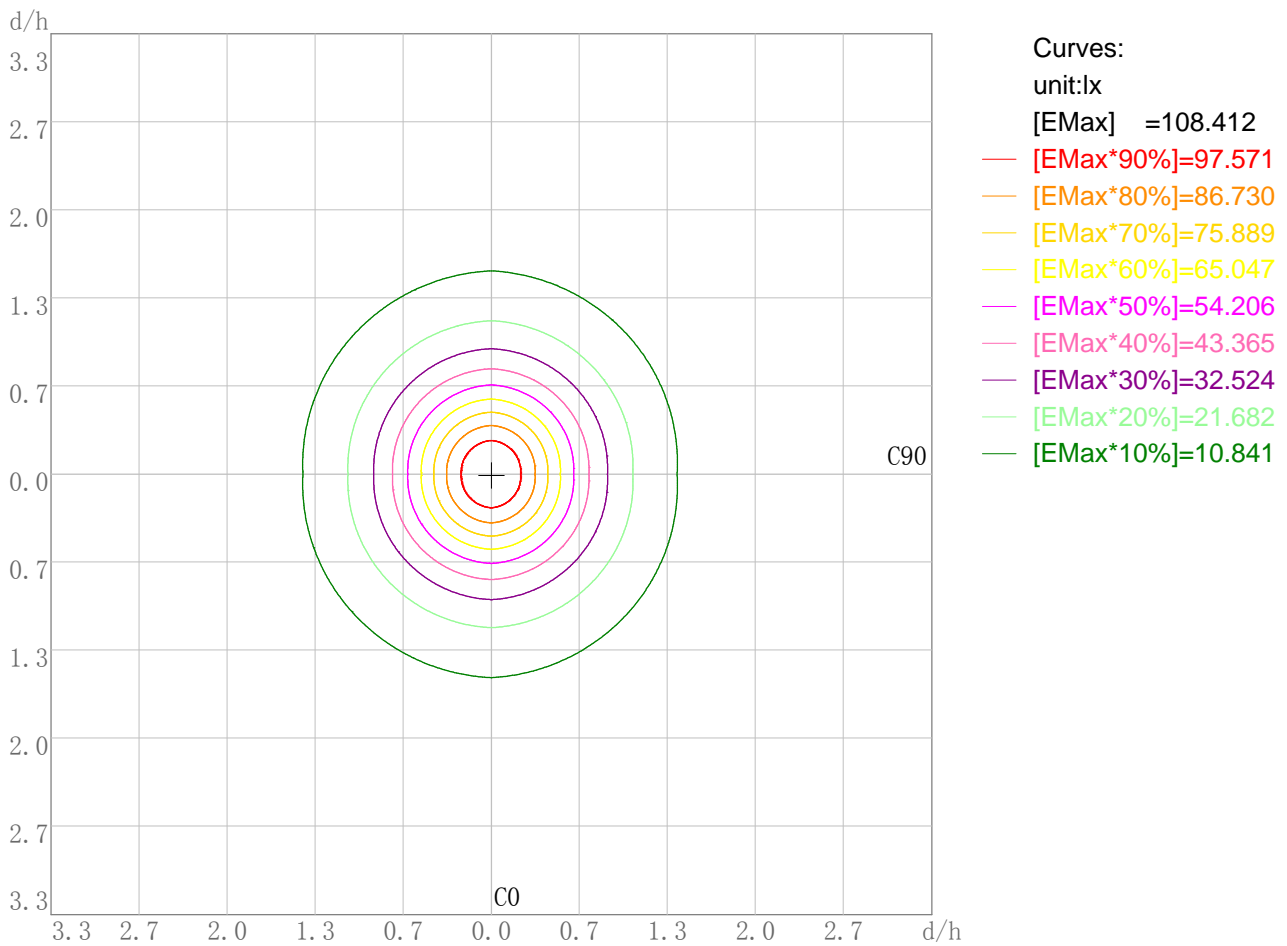

Working Plane Luminaire Mounting Height(m): 3.00
 Working Plane Maximum Illuminance(lx): 108.41
 Working Plane Maximum Illuminance Position(d/h): H0.0 V0.0

3D Plane ISO Illuminance Diagram

Lum. Name: B40W-CC-MS-E 6K	Lum. Catalog: LEDE BATTEN	Test ID:
Lamp Name: 6000K	Lamp Catalog: SMD2835	Test Lab:
Manufacture:	Test Machine: GON-2000	Test Date: 2018/11/01

3D Plane Illuminance Modal

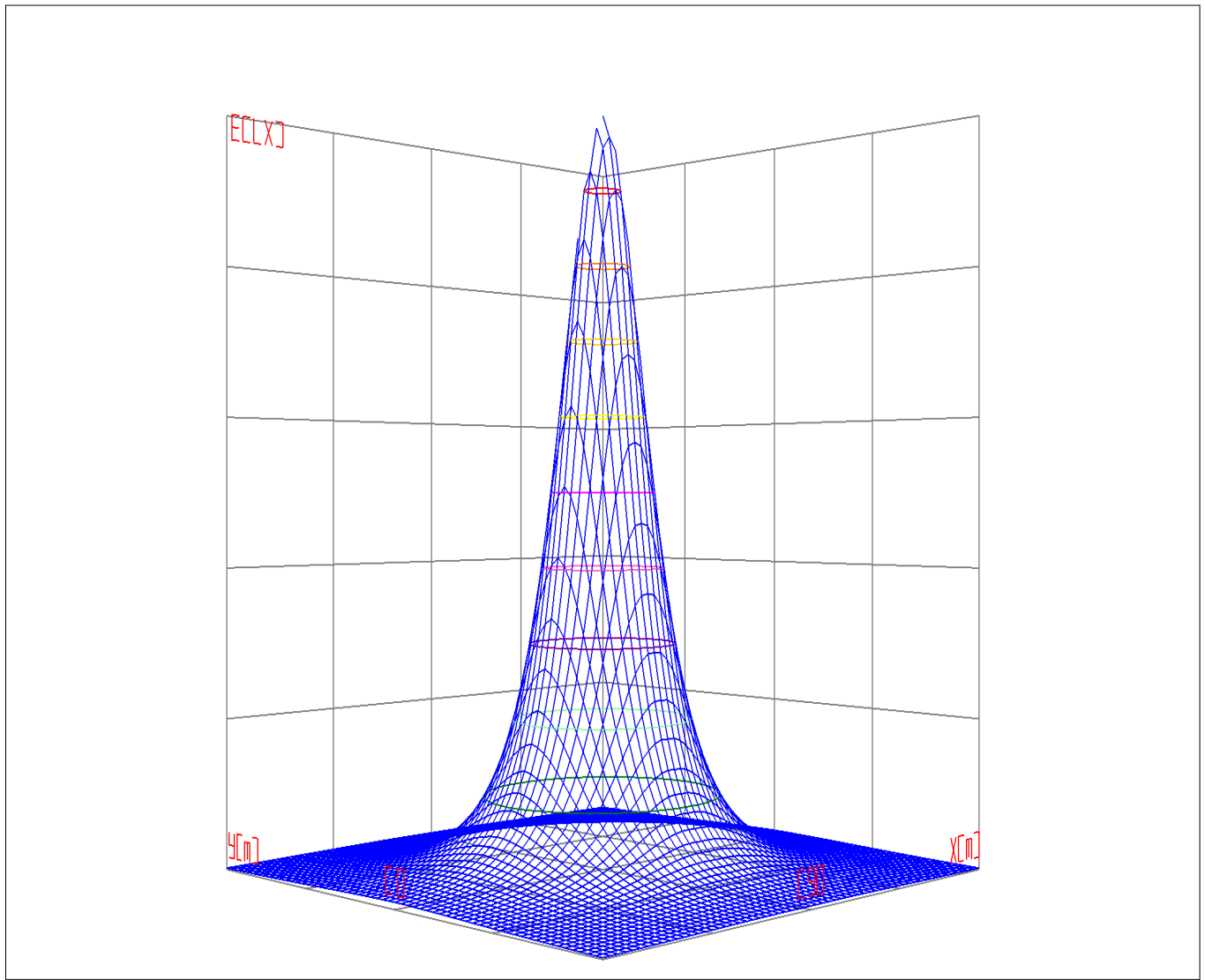

Curves: 3D Model — 90% — 80% — 70% — 60% — 50% — 40% — 30% — 20% — 10% —
View Angles(deg): 0 Height(m): 3.0 Distance(m): 10.0

Space ISO Illuminance Diagram

Lum. Name: B40W-CC-MS-E 6K	Lum. Catalog: LEDE BATTEN	Test ID:
Lamp Name: 6000K	Lamp Catalog: SMD2835	Test Lab:
Manufacture:	Test Machine: GON-2000	Test Date: 2018/11/01

Space ISO Illuminance Curve

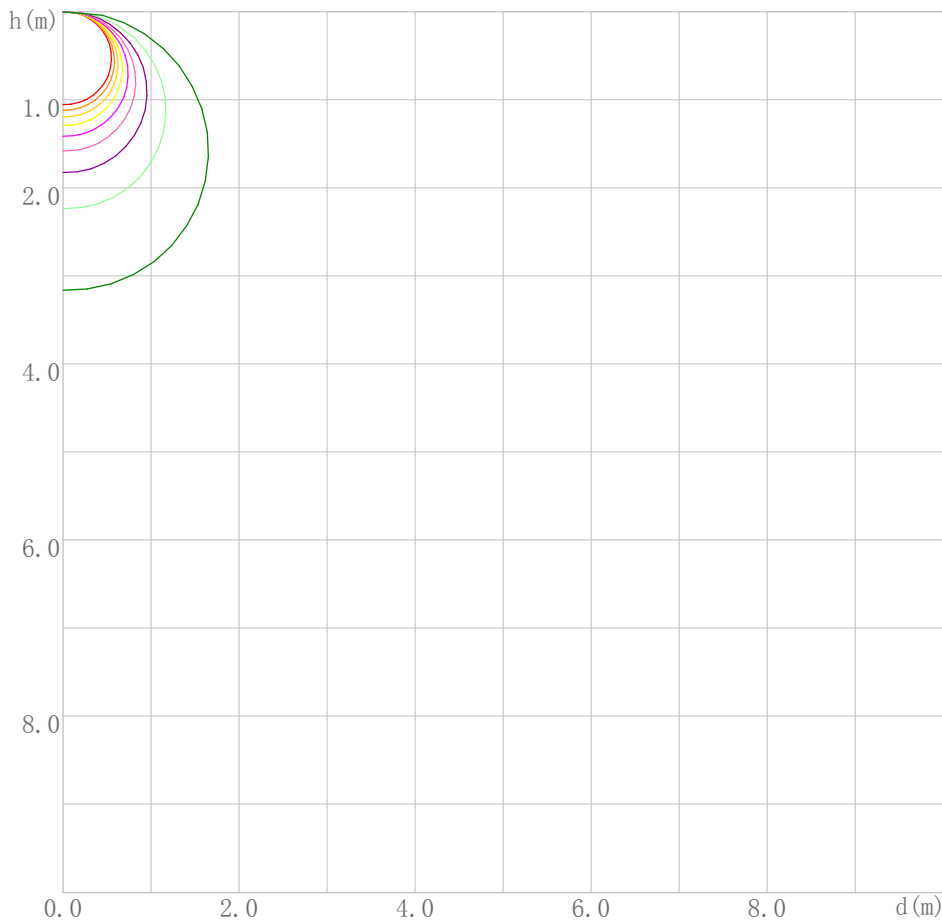

- Curves:
unit:lx
[EMax] =975.666
- [EMax*90%]=878.099
 - [EMax*80%]=780.533
 - [EMax*70%]=682.966
 - [EMax*60%]=585.400
 - [EMax*50%]=487.833
 - [EMax*40%]=390.266
 - [EMax*30%]=292.700
 - [EMax*20%]=195.133
 - [EMax*10%]=97.567

Space Plane Maximum Illuminance and @Angle:975.67,0.0deg
Plane Maximum Lighting Intensity and @Angle:977.242cd,0deg

Illuminance-Distance Diagram

Lum. Name: B40W-CC-MS-E 6K	Lum. Catalog: LEDE BATTEN	Test ID:
Lamp Name: 6000K	Lamp Catalog: SMD2835	Test Lab:
Manufacture:	Test Machine: GON-2000	Test Date: 2018/11/01

Illuminance-Distance Curve

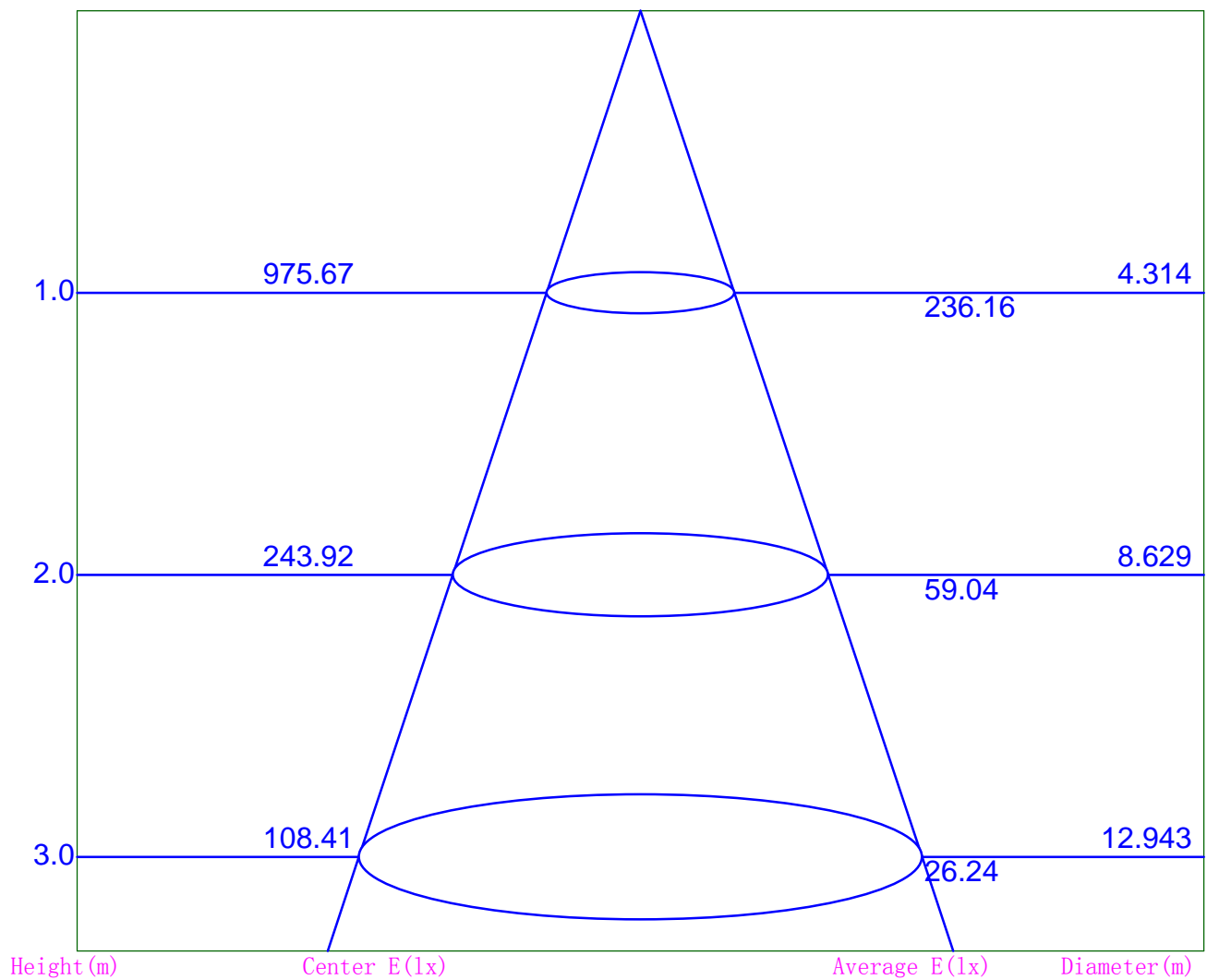

Beam Angle: 130.3

Indoor Luminance Limiting Curves

Lum. Name: B40W-CC-MS-E 6K	Lum. Catalog: LEDE BATTEN	Test ID:
Lamp Name: 6000K	Lamp Catalog: SMD2835	Test Lab:
Manufacture:	Test Machine: GON-2000	Test Date: 2018/11/01

Glare Grade Table

GI	Quality	Using Illuminance							
		a	b	c	d	e	f	g	h
1.15	A	2000	1000	500	<=300				
1.5	B		2000	1000	500	<=300			
1.85	C			2000	1000	500	<=300		
2.2	D				2000	1000	500	<=300	
2.55	E	a				2000	1000	500	<=300
			b	c	d	e	f	g	h

Luminance Table

Gama (deg)	45	50	55	60	65	70	75	80	85
C0	6115	6205	6317	6460	6661	6983	7593	9145	14906
C90	5209	5096	4948	4746	4469	4074	3493	2634	1433

Luminance Limiting Curve

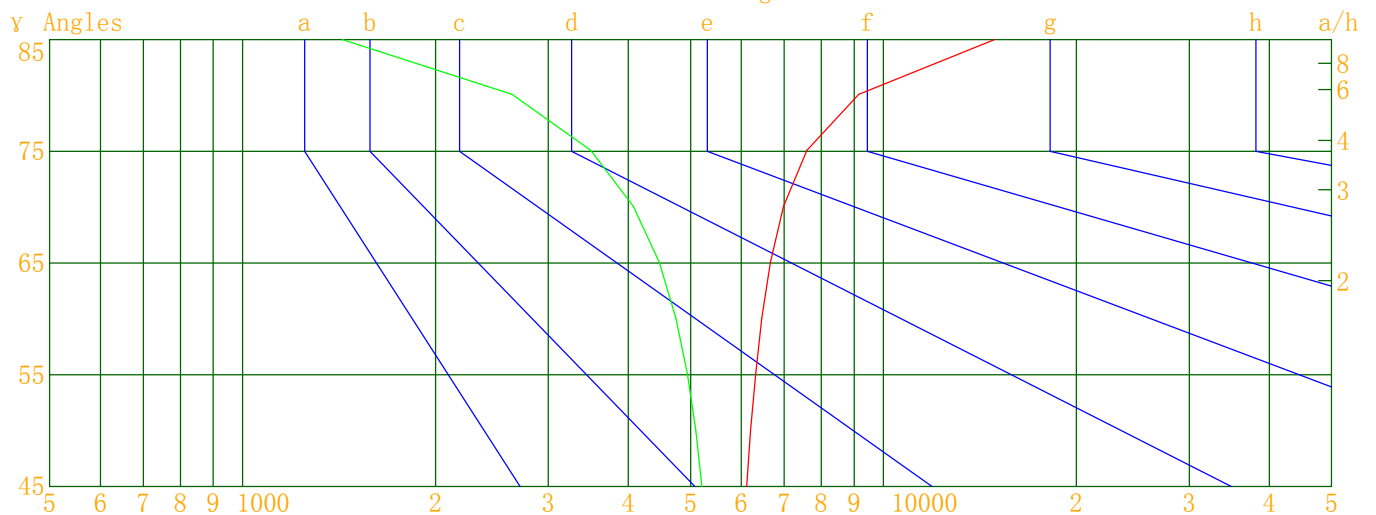

Luminous Size: Length(m)=1.200 Width(m)=0.080 Height(m)=0.065 Area(m²)=0.174000
 Luminous Type: Without Luminous Side
 Luminous Curves: C0-C180 Color: — C90-C270 Color: —

Indoor Budgetary Estimate Table

Lum. Name: B40W-CC-MS-E 6K	Lum. Catalog: LEDE BATTEN	Test ID:
Lamp Name: 6000K	Lamp Catalog: SMD2835	Test Lab:
Manufacture:	Test Machine: GON-2000	Test Date: 2018/11/01

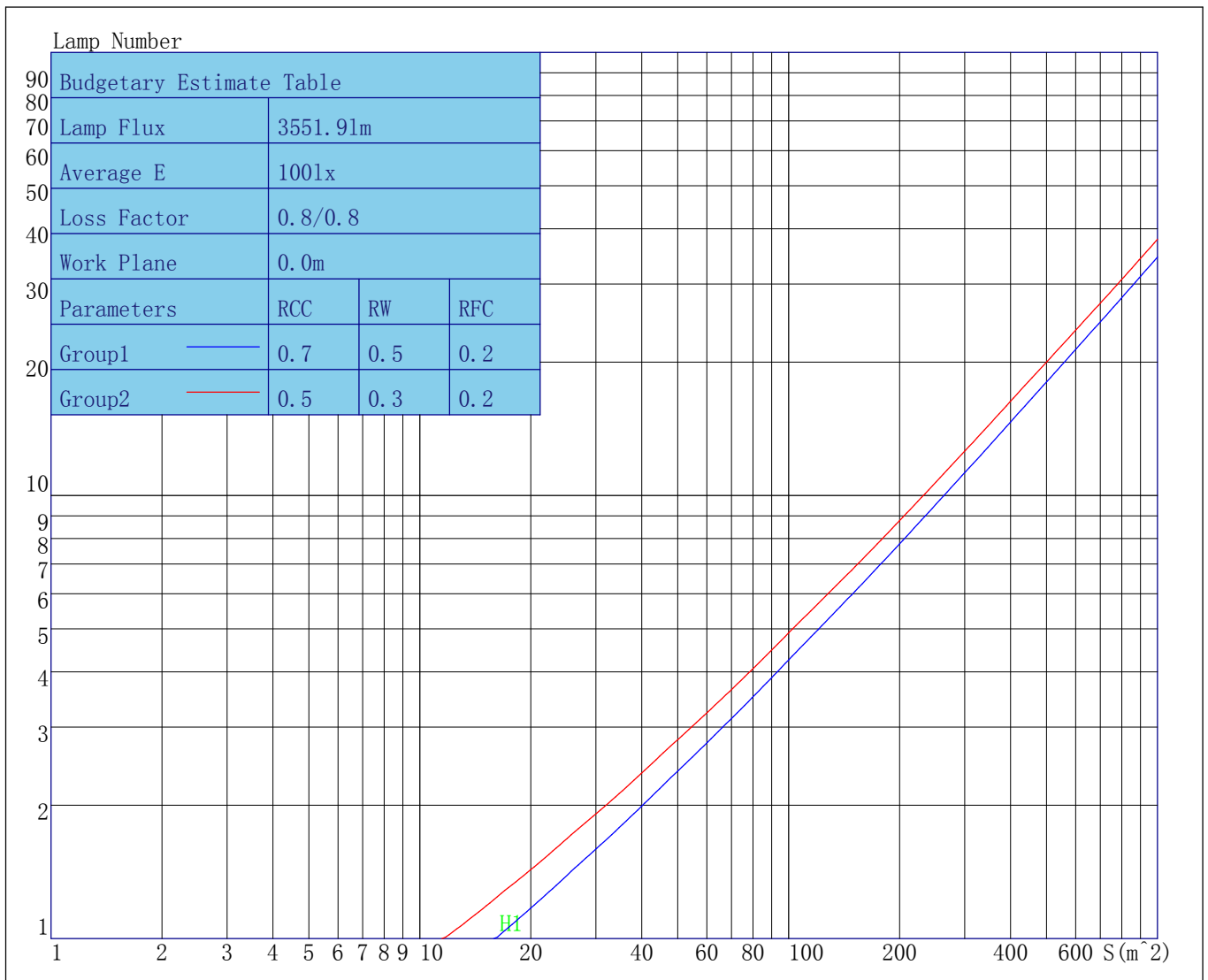

Parameters1: Rhocc = 0.7 Rhow = 0.5 Rhofc = 0.2 LLF = 0.8
 Parameters2: Rhocc = 0.5 Rhow = 0.3 Rhofc = 0.2 LLF = 0.8
 Average Illuminance(lx): 100 Cavity Height: H1(m) = 2

Indoor Coefficient of Utilization Table

Lum. Name: B40W-CC-MS-E 6K	Lum. Catalog: LEDE BATTEN	Test ID:
Lamp Name: 6000K	Lamp Catalog: SMD2835	Test Lab:
Manufacture:	Test Machine: GON-2000	Test Date: 2018/11/01

Coefficients of Utilization - Zonal Cavity Method																		
Coef.	Effective Floor Cavity Reflectance RFC=0.20																	
RhoCC (%)	80				70				50			30			10			0
RhoW (%)	70	50	30	10	70	50	30	10	50	30	10	50	30	10	50	30	10	0
RCR	Coefficient of Utilization (%)																	
0	116	116	116	116	112	112	112	112	105	105	105	98	98	98	92	92	92	89
1	105	100	95	91	101	96	92	88	90	87	83	84	81	79	79	77	75	72
2	95	86	79	73	91	83	77	71	78	72	68	73	68	65	68	65	62	59
3	86	75	67	60	83	73	65	59	68	62	56	64	58	54	60	55	52	49
4	79	66	57	50	75	64	56	49	60	53	48	57	51	46	53	48	44	41
5	72	59	50	43	69	57	49	42	54	46	41	51	44	39	48	42	38	35
6	67	53	44	37	64	51	43	37	48	41	36	46	39	34	43	38	33	31
7	62	48	39	33	59	47	38	32	44	37	31	42	35	30	39	34	29	27
8	57	44	35	29	55	42	34	29	40	33	28	38	32	27	36	30	26	24
9	53	40	32	26	51	39	31	26	37	30	25	35	29	24	33	28	24	22
10	50	37	29	23	48	36	28	23	34	27	23	32	26	22	31	25	21	19

Unified Glare Rating Table

Lum. Name: B40W-CC-MS-E 6K	Lum. Catalog: LEDE BATTEN	Test ID:
Lamp Name: 6000K	Lamp Catalog: SMD2835	Test Lab:
Manufacture:	Test Machine: GON-2000	Test Date: 2018/11/01

Unified Glare Rating Table

Ceiling RCC	0.70	0.70	0.50	0.50	0.30	0.70	0.70	0.50	0.50	0.30
Wall RW	0.50	0.30	0.50	0.30	0.30	0.50	0.30	0.50	0.30	0.30
Floor RFC	0.20	0.20	0.20	0.20	0.20	0.20	0.20	0.20	0.20	0.20
Room Size	Vewed crosswise					Vewed endwise				
X=2H Y=2H	17.4	20.7	18.6	22.0	23.2	15.9	19.2	17.1	20.4	21.7
Y=3H	23.2	26.5	24.4	27.8	29.0	20.2	23.5	21.4	24.7	26.0
Y=4H	26.8	29.8	28.1	31.0	32.3	22.5	25.5	23.8	26.7	28.0
Y=6H	30.1	32.9	31.3	34.2	35.5	23.8	26.7	25.1	28.0	29.2
Y=8H	31.8	34.6	33.1	35.9	37.2	24.2	27.0	25.5	28.3	29.6
Y=12H	33.8	36.6	35.1	37.9	39.2	24.4	27.2	25.7	28.5	29.7
X=4H Y=2H	18.7	21.6	19.9	22.9	24.1	18.1	21.0	19.3	22.3	23.5
Y=3H	24.7	27.6	26.0	28.9	30.2	22.6	25.6	23.9	26.8	28.1
Y=4H	26.9	28.7	28.4	30.2	31.7	23.6	25.4	25.2	27.0	28.5
Y=6H	30.7	32.4	32.3	33.9	35.4	25.5	27.2	27.1	28.7	30.3
Y=8H	32.9	34.5	34.5	36.0	37.5	26.2	27.8	27.8	29.4	30.9
Y=12H	34.5	35.8	36.2	37.5	39.1	25.8	27.1	27.4	28.8	30.4
X=8H Y=4H	27.2	28.8	28.8	30.4	31.9	24.6	26.2	26.2	27.8	29.3
Y=6H	30.5	31.7	32.2	33.3	35.0	26.2	27.3	27.9	29.0	30.6
Y=8H	32.5	33.4	34.3	35.2	36.8	26.8	27.7	28.6	29.5	31.2
Y=12H	35.4	36.3	37.2	38.0	39.7	27.7	28.6	29.5	30.3	32.0
X=12H Y=4H	26.3	27.7	28.0	29.3	30.9	24.0	25.3	25.7	27.0	28.6
Y=6H	30.1	31.0	31.9	32.8	34.5	26.1	27.1	27.9	28.8	30.5
Y=8H	32.6	33.5	34.4	35.2	36.9	27.4	28.2	29.2	30.0	31.7
Variations with the observer position at spacings										
S=1.0H	2.1/-1.9					2.3/-0.3				
S=1.5H	-1.9/-20.1					-0.3/-16.9				
S=2.0H	-1.9/-20.1					-0.3/-16.9				

IES Indoor Report

Photometric Filename: B40W-CC-MS-E 6K.IES

Candela Tabulation

V/H	C0.0	C90.0	C180.0	C270.0
Y 0.0	975.67	975.67	975.67	975.67
Y 5.0	977.24	967.81	977.14	970.61
Y 10.0	974.26	953.79	973.66	959.36
Y 15.0	964.09	931.50	963.40	939.51
Y 20.0	946.33	901.02	945.91	911.68
Y 25.0	921.23	863.01	920.87	875.76
Y 30.0	888.72	817.49	888.71	832.60
Y 35.0	849.78	765.21	849.27	781.91
Y 40.0	803.84	706.25	803.35	724.64
Y 45.0	752.31	640.94	751.59	660.84
Y 50.0	693.97	570.00	693.80	591.01
Y 55.0	630.43	493.80	630.83	515.92
Y 60.0	562.02	412.93	563.07	435.78
Y 65.0	489.79	328.66	491.30	351.74
Y 70.0	415.57	242.45	416.87	265.13
Y 75.0	341.95	157.32	342.70	178.50
Y 80.0	276.32	79.60	276.18	97.48
Y 85.0	226.05	21.73	227.22	33.00
Y 90.0	194.03	4.76	193.68	7.58
Y 95.0	176.72	5.52	170.93	7.40
Y 100.0	166.25	6.23	156.98	7.51
Y 105.0	155.56	7.02	145.58	7.99
Y 110.0	142.48	7.69	134.18	8.49
Y 115.0	132.19	8.36	125.30	9.00
Y 120.0	122.06	9.07	116.61	9.58
Y 125.0	110.92	9.68	107.70	10.10
Y 130.0	97.36	10.30	98.57	10.68
Y 135.0	89.00	10.94	89.17	11.24
Y 140.0	82.87	11.60	79.65	11.89
Y 145.0	72.83	12.31	70.03	12.51
Y 150.0	61.83	13.05	59.09	13.24
Y 155.0	52.31	13.72	50.31	13.86
Y 160.0	42.75	14.29	41.04	14.45
Y 165.0	33.76	14.82	32.58	14.96
Y 170.0	26.13	15.30	25.37	15.36
Y 175.0	19.28	15.51	18.92	15.59
Y 180.0	16.08	16.08	16.08	16.08
