

IES Indoor Report

Photometric Filename: B36W-CC-E-6K-2019-10-28.IES

Indoor Luminaire Photometric Data

Description Information

Lum. Name: B36W-CC-E	Lum. Catalog: LED BATTEN	Test ID:
Lamp Name: 6000K	Lamp Catalog: SMD2835	Test Date: 2019/10/28
Manufacture:	ShldAngle(°):	Test Machine: GON-2000
Test Lab:	Frequency(Hz):	Lamp CCT(K): Ra:
Lum. Size(W*L*H): 0.060m*1.200m*0.065m	Lum. Area(m2): 0.150	Lum. W(kg): 2.000
Test System: C, γ	Test Step: C=90.0 γ=5.0	Temp.(°C): 25
		Humidity(%):

Character Parameter

Lamp Speciality Parameter		Luminaire Speciality Parameter	
Rated Flux(lm): 3751.180	Luminaire Flux: 3751.182lm	Field Angle(10%Imax): 263.2	
Rated Power(W):	Luminaire Efficiency: 100.00%	Down Lumens&Percent: 3296.074lm 87.87%	
Rated Voltage(V):	Luminaire EER(lm/W): 97.814	Up Lumens&Percent: 455.108lm 12.13%	
Tested Power(W): 38.350	Max. Cand. (cd): 1060.561	S/MH: C0_a180=1.308 C90_270=1.211	
Lamps' Inside: 1	Max Cand@Ang. (°): C=180.0 γ=5.0	CIE Type: General Diffuse	
Tested Electric: U=239.8V, I=0.167A, PF=0.000	Beam Angle(50%Imax): 129.2	ErP Φuse(120°): 2419.025lm	
Lamp Size(W*L*H): 0.060m*1.200m*0.065m	Left=-61.2 Right=68.0	IRF: 109.870%	

Lighting Distribution Diagram

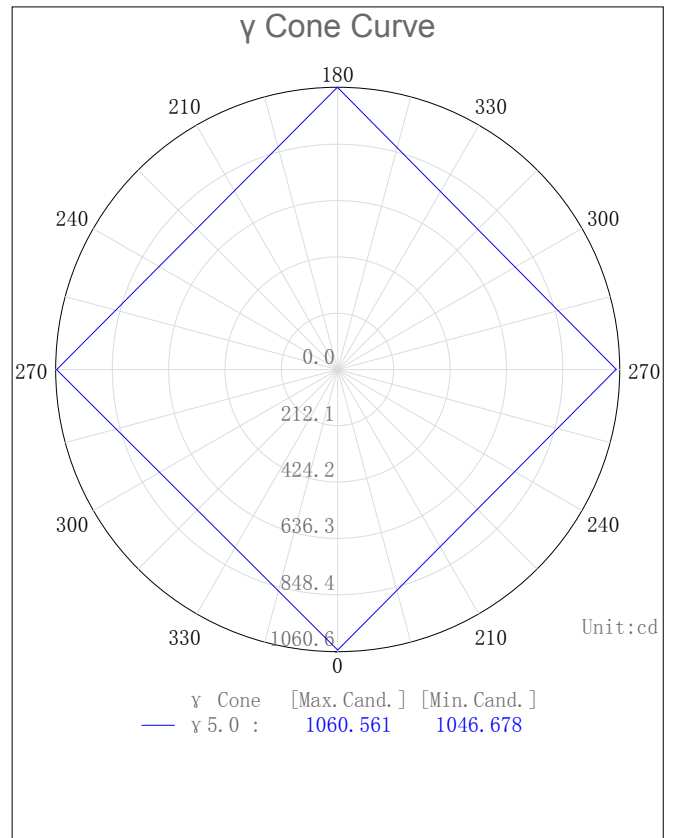
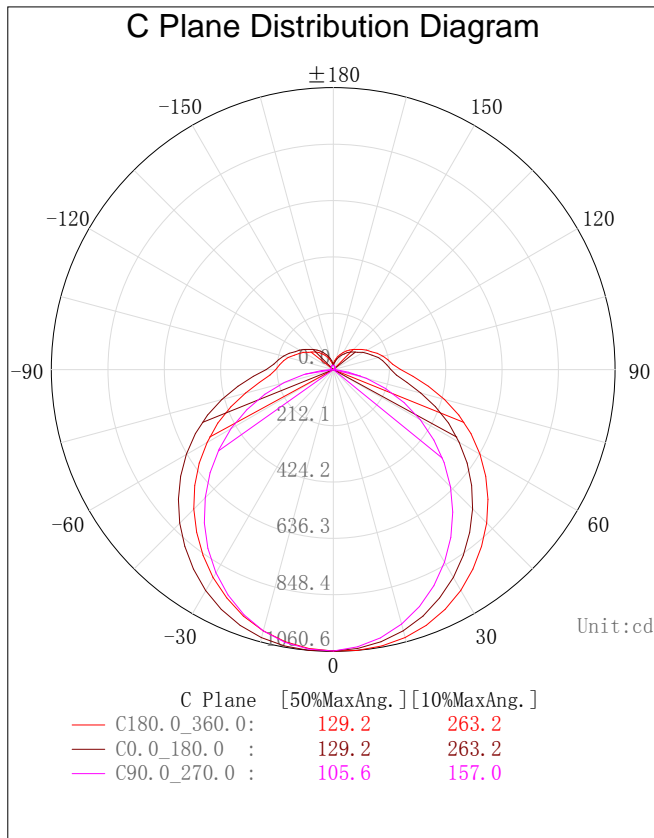

IES Indoor Report

Photometric Filename: B36W-CC-E-6K-2019-10-28.IES

3D Light Intensity Distribution Modal

Lum. Name: B36W-CC-E	Lum. Catalog: LED BATTEN	Test ID:
Lamp Name: 6000K	Lamp Catalog: SMD2835	Test Lab:
Manufacture:	Test Machine: GON-2000	Test Date: 2019/10/28

3D Light Intensity Distribution Modal

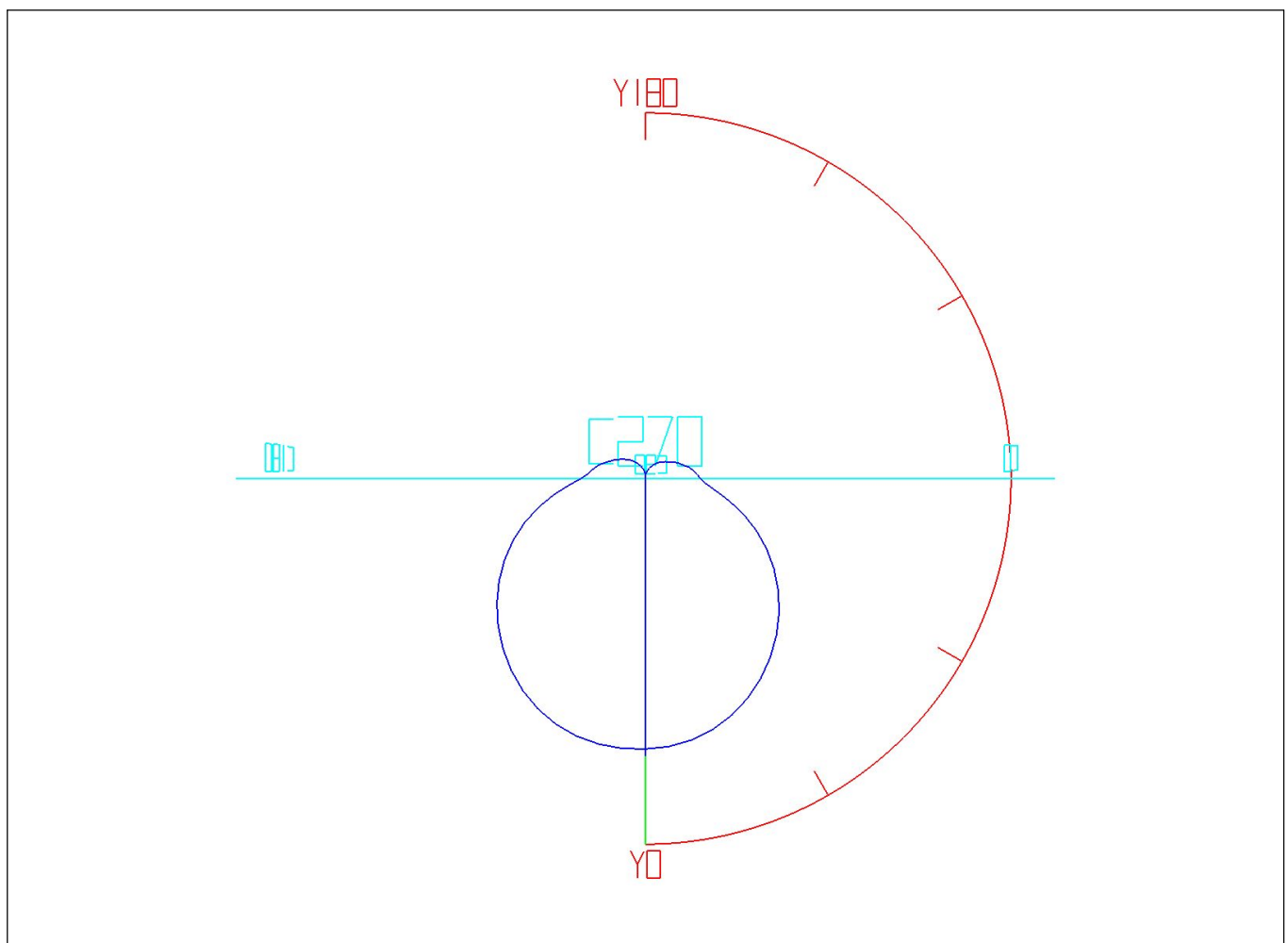

Curves: 3D Model ——— Fixture ——— Vert. HUD ——— Hori. HUD ———
View Angles: Orient:0 Tilt:0 Roll:0 Spin:0

IES Indoor Report

Photometric Filename: B36W-CC-E-6K-2019-10-28.IES

Zonal Flux Tabulation

Zone (y)	Zone Flux (lm)	Sums Flux (lm)	Zone%Lamp	Sums%Lamp
0.0-5.0	25.26	25.26	0.67	0.67
5.0-10.0	74.93	100.19	2.00	2.67
10.0-15.0	122.09	222.27	3.25	5.93
15.0-20.0	165.07	387.34	4.40	10.33
20.0-25.0	202.38	589.72	5.40	15.72
25.0-30.0	232.84	822.55	6.21	21.93
30.0-35.0	255.64	1078.20	6.82	28.74
35.0-40.0	270.36	1348.56	7.21	35.95
40.0-45.0	276.85	1625.41	7.38	43.33
45.0-50.0	275.19	1900.59	7.34	50.67
50.0-55.0	265.69	2166.29	7.08	57.75
55.0-60.0	248.84	2415.12	6.63	64.38
60.0-65.0	225.32	2640.44	6.01	70.39
65.0-70.0	196.08	2836.53	5.23	75.62
70.0-75.0	162.59	2999.11	4.33	79.95
75.0-80.0	127.59	3126.70	3.40	83.35
80.0-85.0	95.76	3222.46	2.55	85.91
85.0-90.0	73.61	3296.07	1.96	87.87
90.0-95.0	62.79	3358.87	1.67	89.54
95.0-100.0	57.49	3416.35	1.53	91.07
100.0-105.0	52.94	3469.30	1.41	92.49
105.0-110.0	47.60	3516.90	1.27	93.75
110.0-115.0	41.87	3558.77	1.12	94.87
115.0-120.0	36.82	3595.59	0.98	95.85
120.0-125.0	31.89	3627.48	0.85	96.70
125.0-130.0	27.22	3654.71	0.73	97.43
130.0-135.0	23.15	3677.85	0.62	98.05
135.0-140.0	19.34	3697.19	0.52	98.56
140.0-145.0	15.79	3712.98	0.42	98.98
145.0-150.0	12.51	3725.50	0.33	99.32
150.0-155.0	9.47	3734.96	0.25	99.57
155.0-160.0	6.83	3741.79	0.18	99.75
160.0-165.0	4.66	3746.45	0.12	99.87
165.0-170.0	2.87	3749.32	0.08	99.95
170.0-175.0	1.45	3750.77	0.04	99.99
175.0-180.0	0.41	3751.18	0.01	100.00

IES Indoor Report

Photometric Filename: B36W-CC-E-6K-2019-10-28.IES

Rectangle ISO Lighting Intensity Diagram

Lum. Name: B36W-CC-E	Lum. Catalog: LED BATTEN	Test ID:
Lamp Name: 6000K	Lamp Catalog: SMD2835	Test Lab:
Manufacture:	Test Machine: GON-2000	Test Date: 2019/10/28

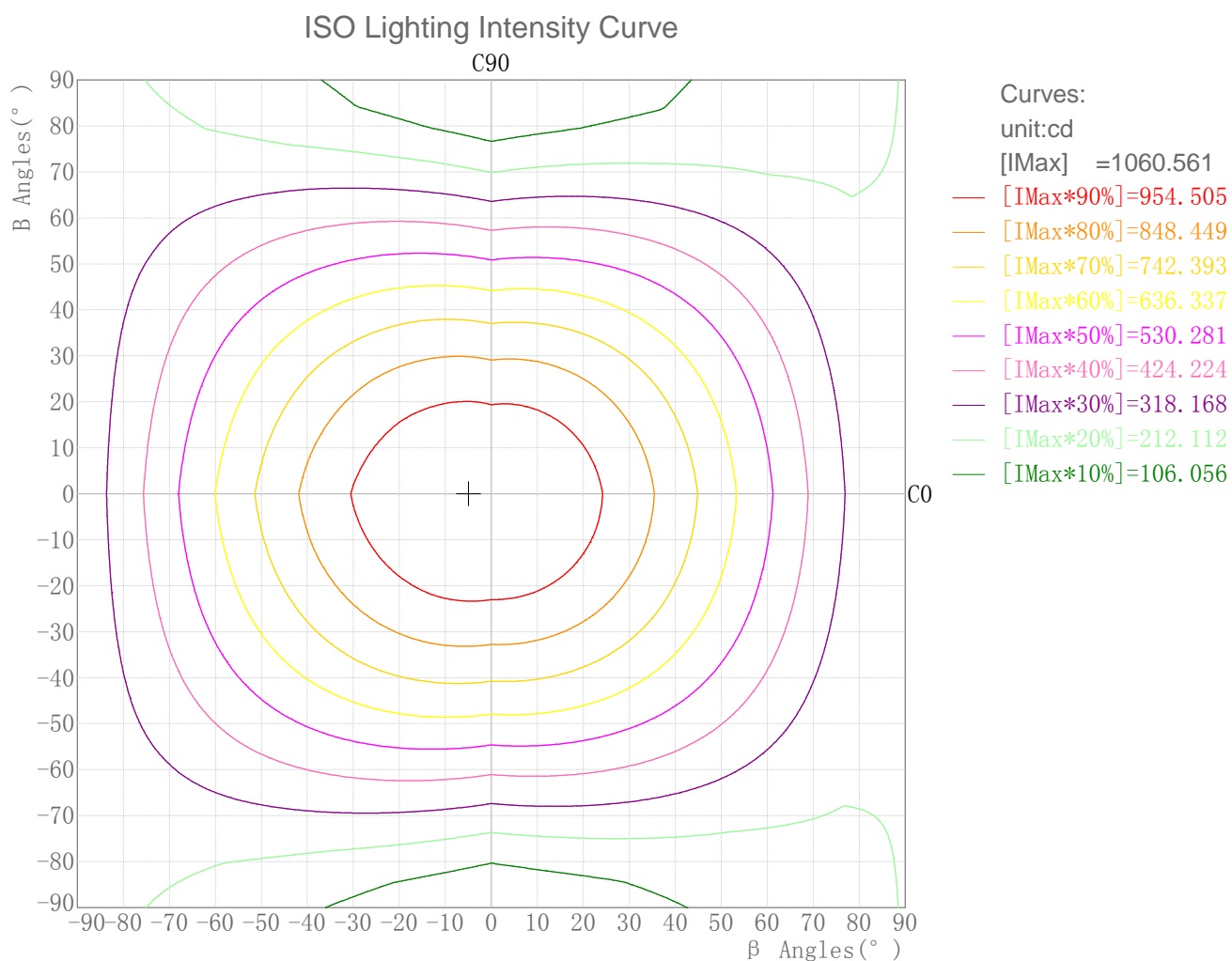

IES Indoor Report

Photometric Filename: B36W-CC-E-6K-2019-10-28.IES

Plane ISO-Illuminance Diagram

Lum. Name: B36W-CC-E	Lum. Catalog: LED BATTEN	Test ID:
Lamp Name: 6000K	Lamp Catalog: SMD2835	Test Lab:
Manufacture:	Test Machine: GON-2000	Test Date: 2019/10/28

Plane ISO-Illuminance Curve

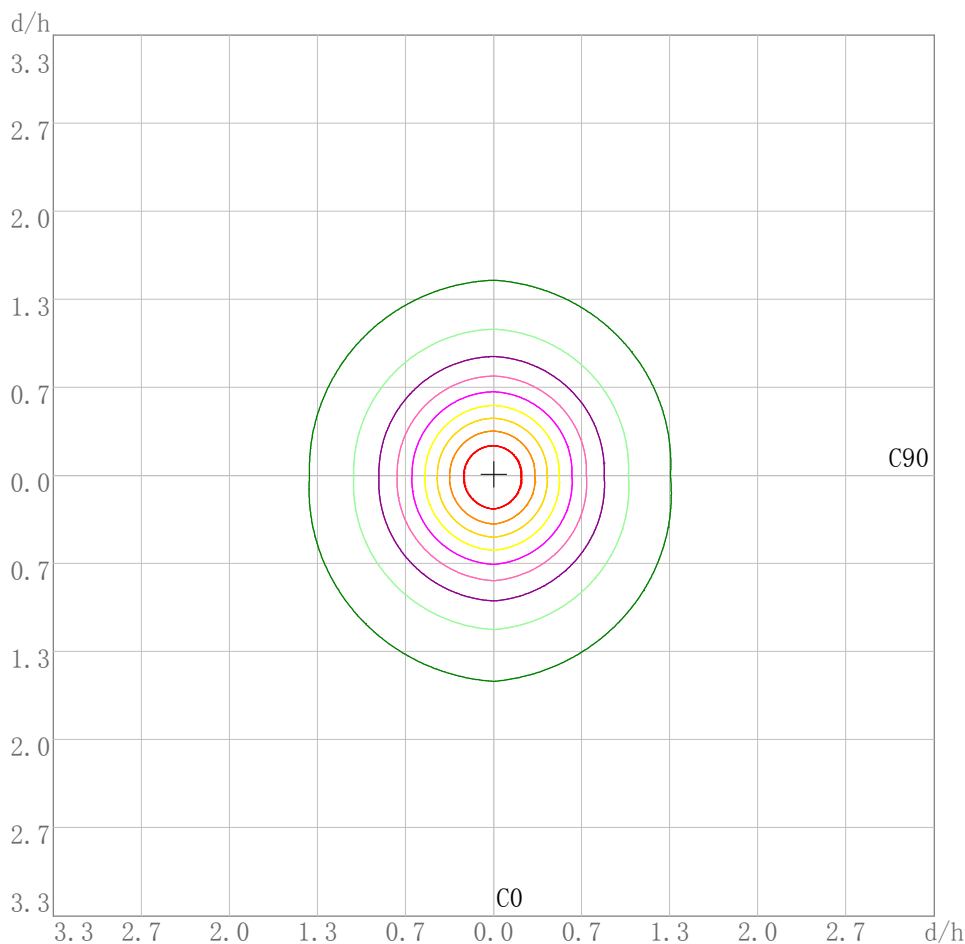

- Curves:**
 unit: lx
 [EMax] = 117.656
- [EMax*90%]=105.890
 - [EMax*80%]=94.125
 - [EMax*70%]=82.359
 - [EMax*60%]=70.593
 - [EMax*50%]=58.828
 - [EMax*40%]=47.062
 - [EMax*30%]=35.297
 - [EMax*20%]=23.531
 - [EMax*10%]=11.766

Working Plane Luminaire Mounting Height(m): 3.00
 Working Plane Maximum Illuminance(lx): 117.66
 Working Plane Maximum Illuminance Position(d/h): H0.0 V-0.0

IES Indoor Report

Photometric Filename: B36W-CC-E-6K-2019-10-28.IES

3D Plane ISO Illuminance Diagram

Lum. Name: B36W-CC-E	Lum. Catalog: LED BATTEN	Test ID:
Lamp Name: 6000K	Lamp Catalog: SMD2835	Test Lab:
Manufacture:	Test Machine: GON-2000	Test Date: 2019/10/28

3D Plane Illuminance Modal

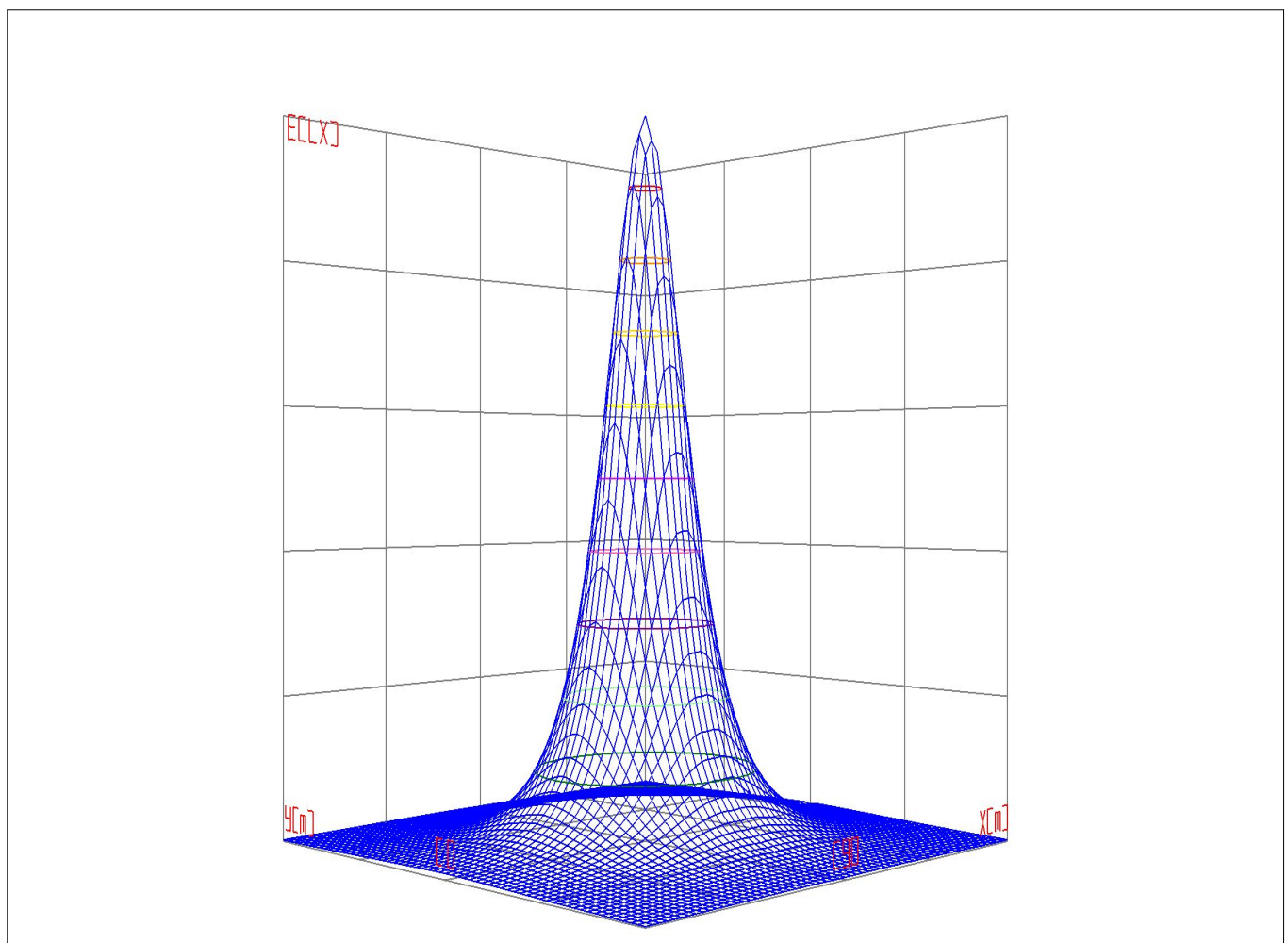

Curves: 3D Model — 90% — 80% — 70% — 60% — 50% — 40% — 30% — 20% — 10% —
View Angles(deg): 0 Height(m): 3.0 Distance(m): 10.0

IES Indoor Report

Photometric Filename: B36W-CC-E-6K-2019-10-28.IES

Space ISO Illuminance Diagram

Lum. Name: B36W-CC-E	Lum. Catalog: LED BATTEN	Test ID:
Lamp Name: 6000K	Lamp Catalog: SMD2835	Test Lab:
Manufacture:	Test Machine: GON-2000	Test Date: 2019/10/28

Space ISO Illuminance Curve

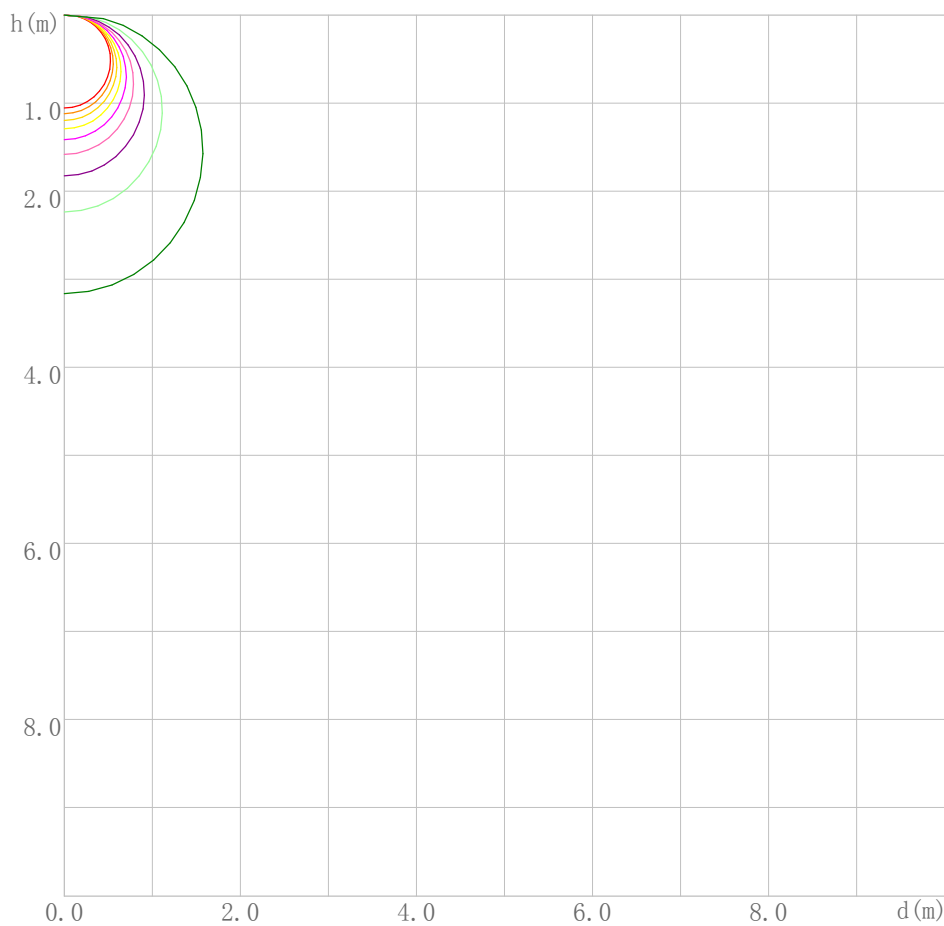

- Curves:
unit: lx
[EMax] = 1058.852
- [EMax*90%]=952.967
 - [EMax*80%]=847.082
 - [EMax*70%]=741.196
 - [EMax*60%]=635.311
 - [EMax*50%]=529.426
 - [EMax*40%]=423.541
 - [EMax*30%]=317.656
 - [EMax*20%]=211.770
 - [EMax*10%]=105.885

Space Plane Maximum Illuminance and @Angle: 1058.85, 0.0deg
Plane Maximum Lighting Intensity and @Angle: 1058.852cd, 0deg

IES Indoor Report

Photometric Filename: B36W-CC-E-6K-2019-10-28.IES

Illuminance-Distance Diagram

Lum. Name: B36W-CC-E	Lum. Catalog: LED BATTEN	Test ID:
Lamp Name: 6000K	Lamp Catalog: SMD2835	Test Lab:
Manufacture:	Test Machine: GON-2000	Test Date: 2019/10/28

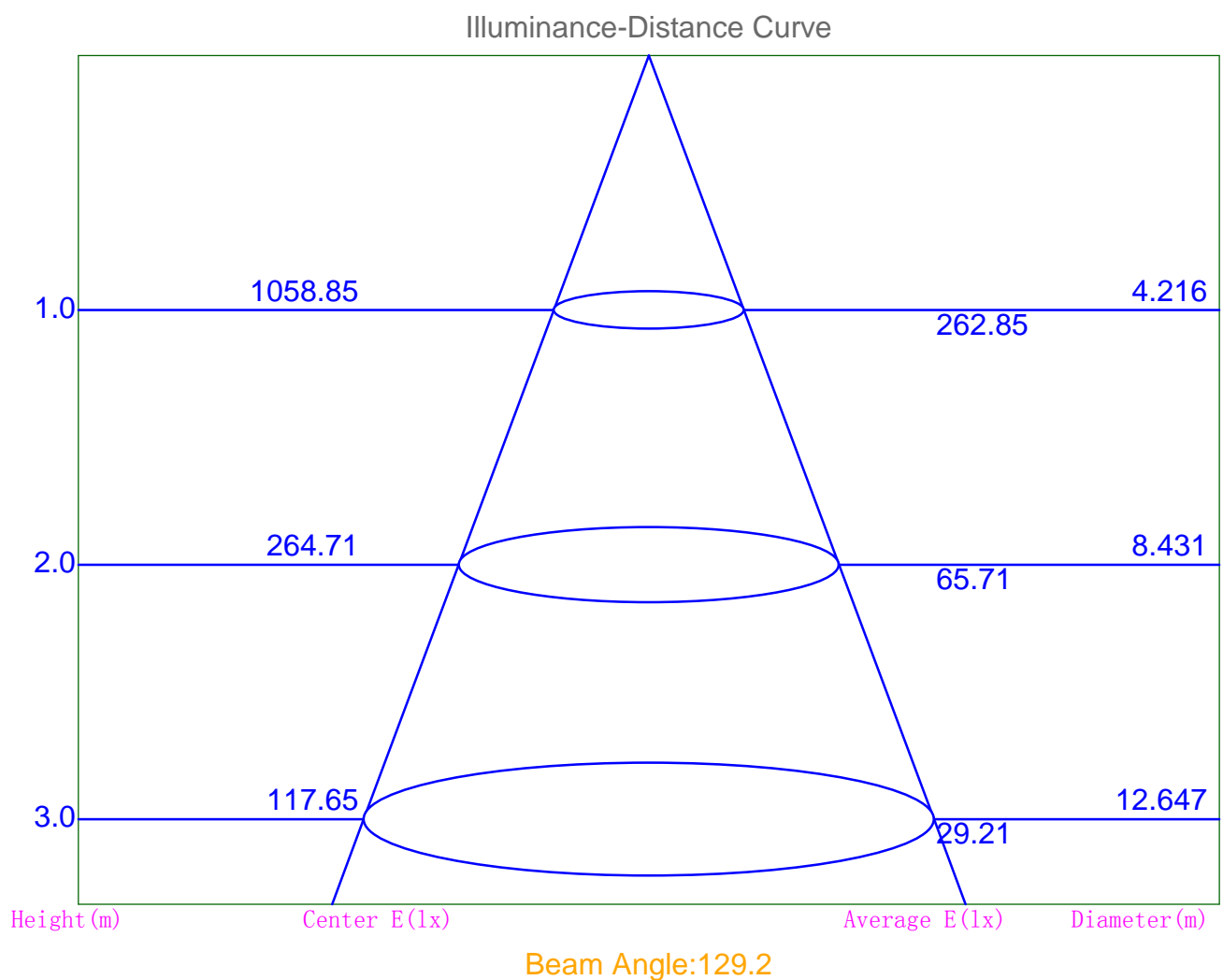

IES Indoor Report

Photometric Filename: B36W-CC-E-6K-2019-10-28.IES

Indoor Luminance Limiting Curves

Lum. Name: B36W-CC-E	Lum. Catalog: LED BATTEN	Test ID:
Lamp Name: 6000K	Lamp Catalog: SMD2835	Test Lab:
Manufacture:	Test Machine: GON-2000	Test Date: 2019/10/28

Glare Grade Table

GI	Quality	Using Illuminance							
		a	b	c	d	e	f	g	h
1.15	A	2000	1000	500	<=300				
1.5	B		2000	1000	500	<=300			
1.85	C			2000	1000	500	<=300		
2.2	D				2000	1000	500	<=300	
2.55	E	a				2000	1000	500	<=300
			b	c	d	e	f	g	h

Luminance Table

Gama (deg)	45	50	55	60	65	70	75	80	85
C0	6983	7042	7143	7298	7547	7970	8783	10798	18279
C90	5880	5646	5375	5048	4641	4088	3327	2247	831

Luminance Limiting Curve

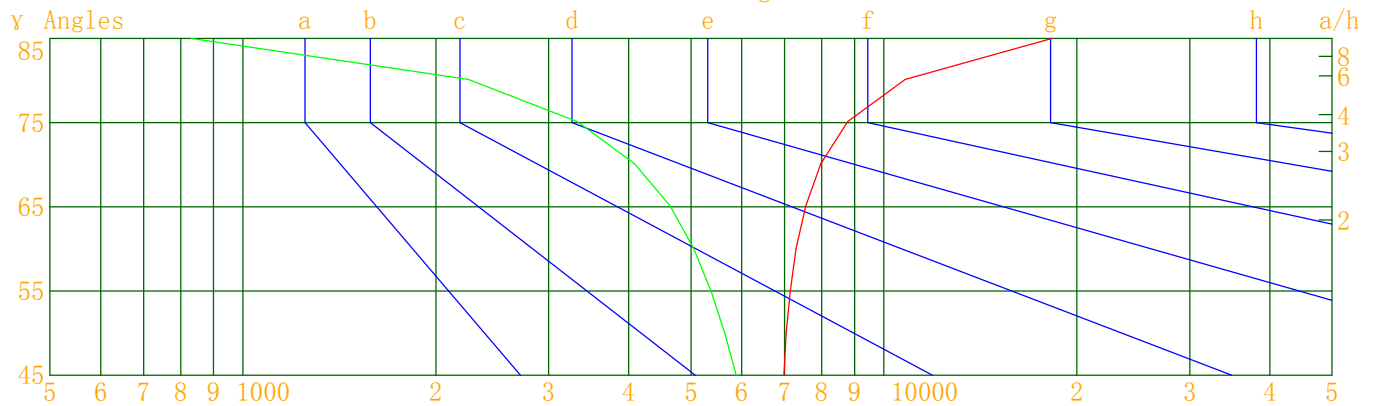

Luminous Size: Length(m)=1.200 Width(m)=0.060 Height(m)=0.065 Area(m^2)=0.150000
 Luminous Type: Without Luminous Side
 Luminous Curves: C0-C180 Color: — C90-C270 Color: —

IES Indoor Report

Photometric Filename: B36W-CC-E-6K-2019-10-28.IES

Indoor Budgetary Estimate Table

Lum. Name: B36W-CC-E	Lum. Catalog: LED BATTEN	Test ID:
Lamp Name: 6000K	Lamp Catalog: SMD2835	Test Lab:
Manufacture:	Test Machine: GON-2000	Test Date: 2019/10/28

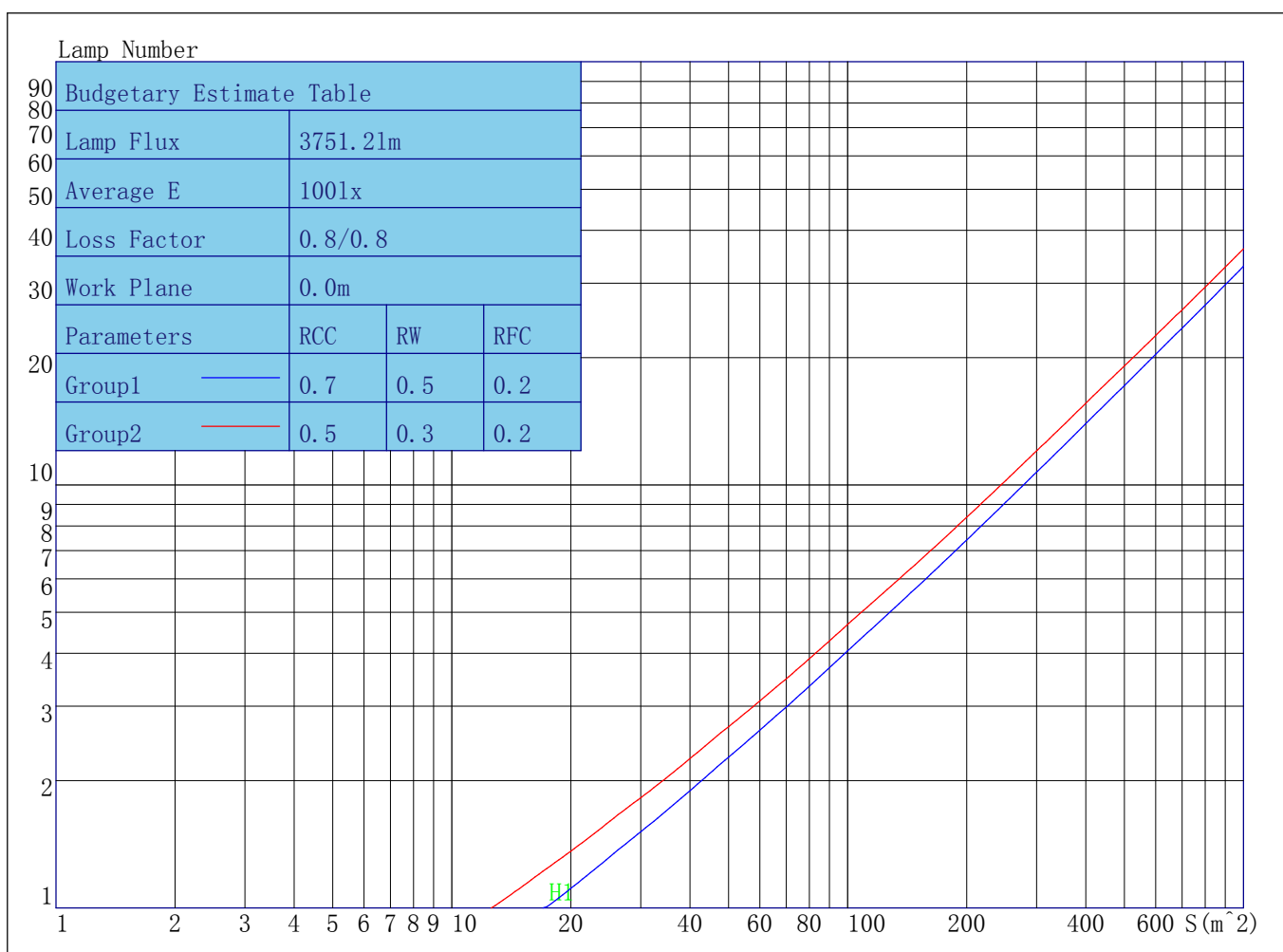

Parameters1: Rhoc = 0.7 Rhow = 0.5 Rhofc = 0.2 LLF = 0.8

Parameters2: Rhoc = 0.5 Rhow = 0.3 Rhofc = 0.2 LLF = 0.8

Average Illuminance(lx): 100 Cavity Height: H1(m) = 2

IES Indoor Report

Photometric Filename: B36W-CC-E-6K-2019-10-28.IES

Indoor Coefficient of Utilization Table

Lum. Name: B36W-CC-E	Lum. Catalog: LED BATTEN	Test ID:
Lamp Name: 6000K	Lamp Catalog: SMD2835	Test Lab:
Manufacture:	Test Machine: GON-2000	Test Date: 2019/10/28

Coefficients of Utilization - Zonal Cavity Method																		
Coef.	Effective Floor Cavity Reflectance RFC=0.20																	
RhoCC (%)	80				70				50			30			10			0
RhoW (%)	70	50	30	10	70	50	30	10	50	30	10	50	30	10	50	30	10	0
RCR	Coefficient of Utilization (%)																	
0	116	116	116	116	112	112	112	112	104	104	104	97	97	97	91	91	91	88
1	105	99	95	90	101	96	91	88	89	86	83	83	80	78	78	76	74	71
2	95	86	79	72	91	83	76	71	77	72	67	72	68	64	67	64	61	58
3	86	75	66	60	82	72	65	58	68	61	56	63	58	53	59	55	51	48
4	79	66	57	50	75	64	56	49	60	53	47	56	50	45	53	48	43	41
5	72	59	50	43	69	57	49	42	54	46	41	50	44	39	47	42	38	35
6	66	53	44	37	64	51	43	37	48	41	35	45	39	34	43	37	33	31
7	62	48	39	33	59	46	38	32	44	37	31	41	35	30	39	33	29	27
8	57	44	35	29	55	42	34	29	40	33	28	38	32	27	36	30	26	24
9	53	40	32	26	51	39	31	26	37	30	25	35	29	24	33	28	23	22
10	50	37	29	24	48	36	28	23	34	27	23	32	26	22	31	25	21	19

IES Indoor Report

Photometric Filename: B36W-CC-E-6K-2019-10-28.IES

Unified Glare Rating Table

Lum. Name: B36W-CC-E	Lum. Catalog: LED BATTEN	Test ID:
Lamp Name: 6000K	Lamp Catalog: SMD2835	Test Lab:
Manufacture:	Test Machine: GON-2000	Test Date: 2019/10/28

Unified Glare Rating Table

Ceiling RCC	0.70	0.70	0.50	0.50	0.30	0.70	0.70	0.50	0.50	0.30
Wall RW	0.50	0.30	0.50	0.30	0.30	0.50	0.30	0.50	0.30	0.30
Floor RFC	0.20	0.20	0.20	0.20	0.20	0.20	0.20	0.20	0.20	0.20
Room Size	Viewed crosswise					Viewed endwise				
X=2H Y=2H	17.1	20.4	18.3	21.7	23.0	15.3	18.6	16.6	19.9	21.2
Y=3H	22.9	26.2	24.1	27.5	28.8	19.3	22.6	20.5	23.9	25.2
Y=4H	26.6	29.5	27.9	30.8	32.1	21.4	24.3	22.7	25.7	27.0
Y=6H	30.0	32.8	31.3	34.1	35.5	22.5	25.3	23.8	26.7	28.0
Y=8H	31.9	34.7	33.2	36.0	37.3	22.8	25.6	24.1	26.9	28.3
Y=12H	34.1	36.8	35.4	38.2	39.5	22.9	25.7	24.2	27.0	28.4
X=4H Y=2H	18.2	21.1	19.5	22.4	23.8	17.5	20.4	18.8	21.8	23.1
Y=3H	24.3	27.2	25.6	28.5	29.8	21.8	24.7	23.1	26.0	27.4
Y=4H	26.5	28.3	28.1	29.9	31.5	22.6	24.4	24.2	26.0	27.6
Y=6H	30.5	32.2	32.1	33.8	35.3	24.3	26.0	25.9	27.6	29.2
Y=8H	32.8	34.4	34.4	36.0	37.6	24.9	26.5	26.5	28.1	29.7
Y=12H	34.7	36.0	36.4	37.7	39.4	24.4	25.7	26.1	27.5	29.1
X=8H Y=4H	26.8	28.4	28.4	30.0	31.6	23.7	25.3	25.3	26.9	28.5
Y=6H	30.3	31.4	32.0	33.1	34.8	25.1	26.3	26.9	28.0	29.7
Y=8H	32.4	33.3	34.2	35.1	36.9	25.7	26.7	27.5	28.5	30.2
Y=12H	35.6	36.5	37.5	38.3	40.1	26.6	27.5	28.4	29.3	31.0
X=12H Y=4H	25.9	27.2	27.6	29.0	30.6	23.1	24.4	24.8	26.1	27.8
Y=6H	29.8	30.8	31.6	32.6	34.3	25.1	26.1	27.0	27.9	29.7
Y=8H	32.5	33.4	34.3	35.2	36.9	26.4	27.3	28.3	29.1	30.9
Variations with the observer position at spacings										
S=1.0H	2.1/-2.0					2.4/-0.2				
S=1.5H	-2.0/-20.6					-0.2/-16.7				
S=2.0H	-2.0/-20.6					-0.2/-16.7				

IES Indoor Report

Photometric Filename: B36W-CC-E-6K-2019-10-28.IES

Candela Tabulation

V/H	C0.0	C90.0	C180.0	C270.0
Y 0.0	1058.85	1058.85	1058.85	1058.85
Y 5.0	1053.39	1046.68	1060.56	1055.48
Y 10.0	1039.66	1024.81	1055.53	1042.03
Y 15.0	1017.35	991.92	1043.83	1017.31
Y 20.0	986.66	948.89	1023.84	981.71
Y 25.0	948.35	897.01	995.43	936.41
Y 30.0	903.36	837.41	959.23	882.33
Y 35.0	853.30	771.13	916.36	821.03
Y 40.0	798.71	699.60	868.23	753.53
Y 45.0	740.61	623.71	815.53	680.90
Y 50.0	678.99	544.37	759.11	604.27
Y 55.0	614.53	462.44	699.60	524.46
Y 60.0	547.34	378.63	636.86	442.28
Y 65.0	478.42	294.24	571.17	358.48
Y 70.0	408.87	209.73	503.02	273.66
Y 75.0	340.99	129.15	432.89	189.82
Y 80.0	281.25	58.54	364.07	110.60
Y 85.0	238.97	10.87	301.14	44.28
Y 90.0	215.61	3.72	252.75	8.01
Y 95.0	201.91	4.36	224.41	6.57
Y 100.0	188.44	5.06	208.73	6.81
Y 105.0	175.40	5.67	194.19	7.17
Y 110.0	155.68	6.51	176.18	7.67
Y 115.0	142.34	7.13	157.57	8.35
Y 120.0	128.82	7.85	144.70	9.03
Y 125.0	113.06	8.54	130.32	9.60
Y 130.0	102.51	9.19	117.39	10.22
Y 135.0	92.42	9.91	105.81	10.76
Y 140.0	82.02	10.62	94.78	11.47
Y 145.0	71.98	11.45	84.17	12.10
Y 150.0	61.37	12.27	73.60	12.91
Y 155.0	50.87	13.04	61.64	13.60
Y 160.0	41.28	13.79	51.84	14.38
Y 165.0	32.76	14.43	42.61	14.93
Y 170.0	24.79	15.07	33.52	15.39
Y 175.0	16.94	15.46	25.28	15.72
Y 180.0	16.08	16.08	16.08	16.08
