

# IES Indoor Report

Photometric Filename: B36W-CC-E-4K-2019-10-28.IES

## Indoor Luminaire Photometric Data

### Description Information

Lum. Name: B36W-CC-E	Lum. Catalog: LED BATTEN	Test ID:
Lamp Name: 4000K	Lamp Catalog: SMD2835	Test Date: 2019/10/28
Manufacture:	ShldAngle(°):	Test Machine: GON-2000
Test Lab:	Frequency(Hz):	Lamp CCT(K): Ra:
Lum. Size(W*L*H): 0.060m*1.200m*0.065m	Lum. Area(m <sup>2</sup> ): 0.150	Lum. W(kg): 2.000
Test System: C, γ	Test Step: C=90.0 γ=5.0	Temp. (°C): 25
		Humidity(%):

### Character Parameter

Lamp Speciality Parameter		Luminaire Speciality Parameter	
Rated Flux(lm): 4065.910	Luminaire Flux: 4065.912lm	Field Angle(10%Imax): 262.3	
Rated Power(W):	Luminaire Efficiency: 100.00%	Down Lumens&Percent: 3573.807lm 87.90%	
Rated Voltage(V):	Luminaire EER(lm/W): 104.954	Up Lumens&Percent: 492.104lm 12.10%	
Tested Power(W): 38.740	Max. Cand. (cd): 1153.459	S/MH: C0_a180=1.306 C90_270=1.209	
Lamps' Inside: 1	Max Cand@Ang. (°): C=180.0 γ=5.0	CIE Type: General Diffuse	
Tested Electric: U=239.3V, I=0.171A, PF=0.000	Beam Angle(50%Imax): 128.8	ErP Φuse(120°): 2622.848lm	
Lamp Size(W*L*H): 0.060m*1.200m*0.065m	Left=-61.6 Right=67.2	IRF: 109.756%	

### Lighting Distribution Diagram

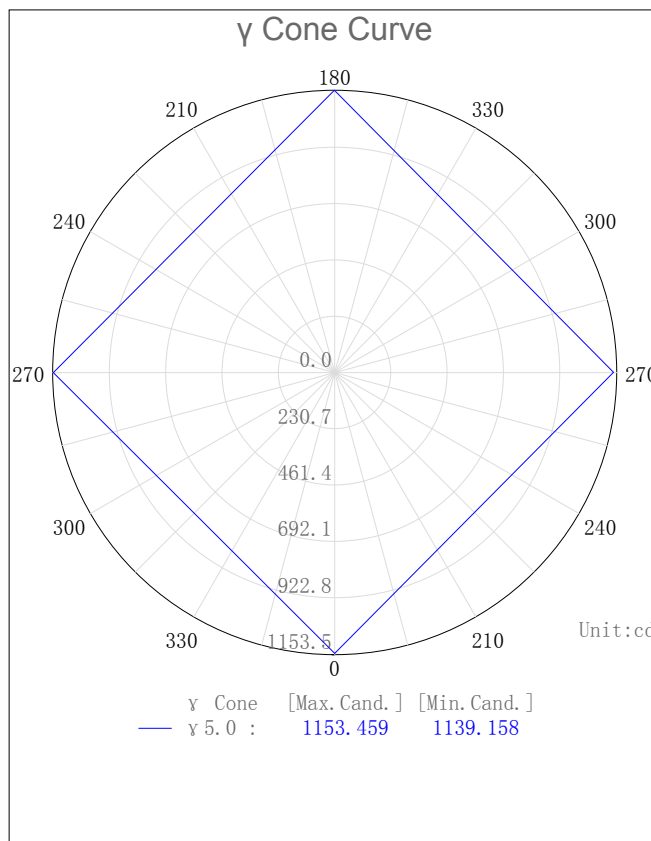
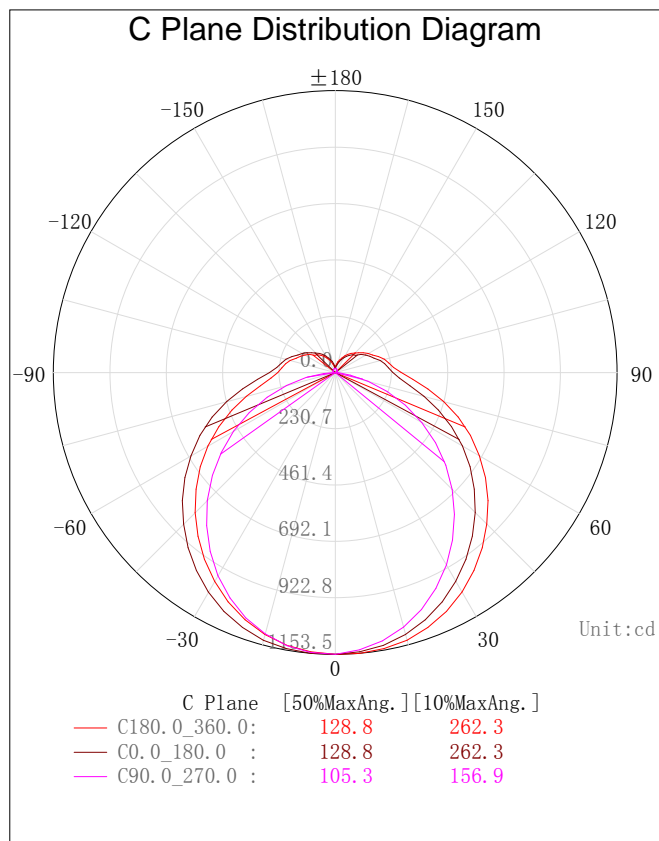

# IES Indoor Report

Photometric Filename: B36W-CC-E-4K-2019-10-28.IES

---

## 3D Light Intensity Distribution Modal

Lum. Name: B36W-CC-E	Lum. Catalog: LED BATTEN	Test ID:
Lamp Name: 4000K	Lamp Catalog: SMD2835	Test Lab:
Manufacture:	Test Machine: GON-2000	Test Date: 2019/10/28

### 3D Light Intensity Distribution Modal

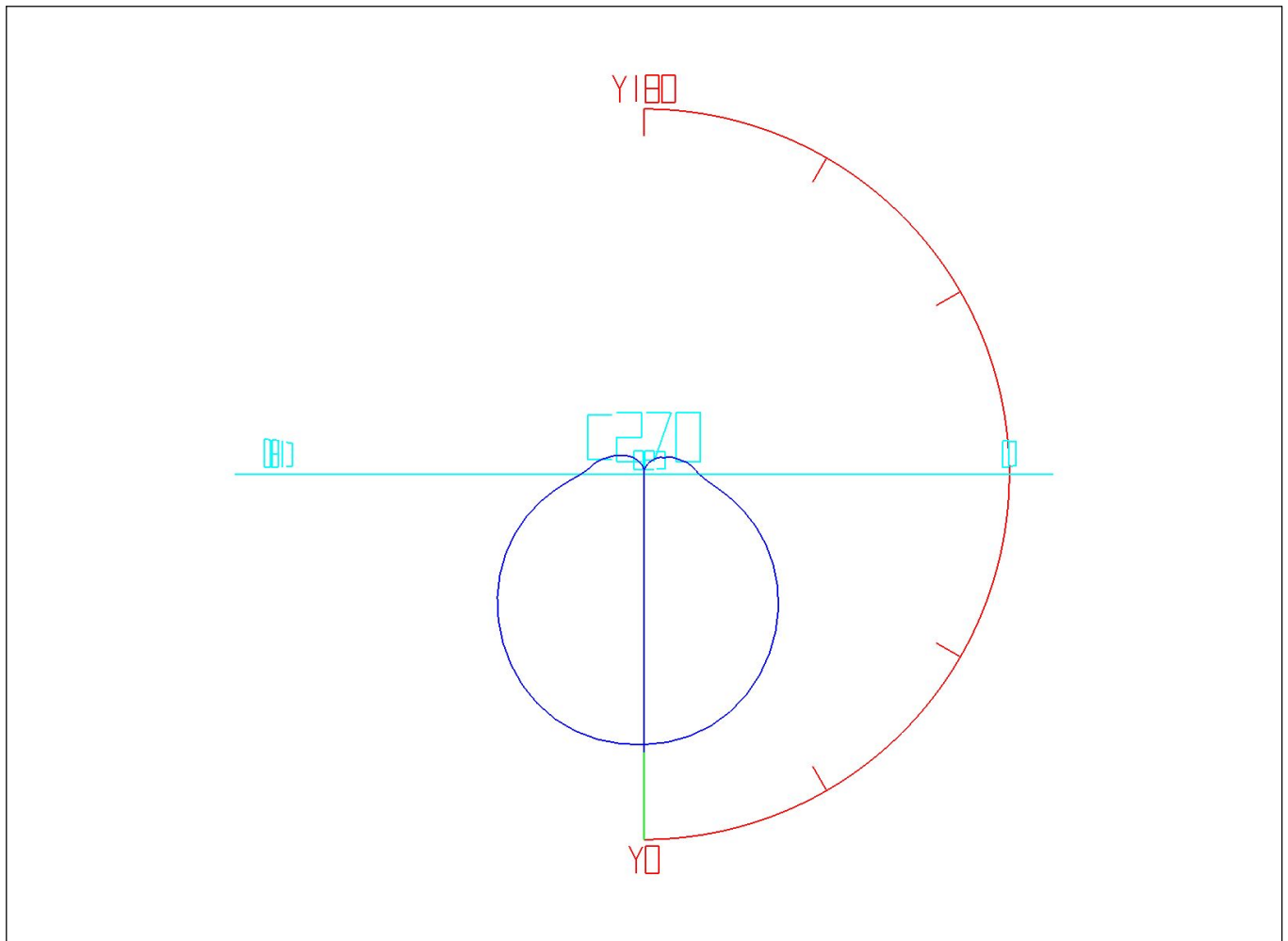

Curves: 3D Model ——— Fixture ——— Vert. HUD ——— Hori. HUD ———  
View Angles: Orient:0 Tilt:0 Roll:0 Spin:0

---

# IES Indoor Report

Photometric Filename: B36W-CC-E-4K-2019-10-28.IES

---

## Zonal Flux Tabulation

Zone ( y )	Zone Flux (lm)	Sums Flux (lm)	Zone%Lamp	Sums%Lamp
0.0-5.0	27.49	27.49	0.68	0.68
5.0-10.0	81.54	109.03	2.01	2.68
10.0-15.0	132.84	241.87	3.27	5.95
15.0-20.0	179.56	421.43	4.42	10.36
20.0-25.0	220.06	641.49	5.41	15.78
25.0-30.0	253.06	894.55	6.22	22.00
30.0-35.0	277.70	1172.24	6.83	28.83
35.0-40.0	293.52	1465.76	7.22	36.05
40.0-45.0	300.39	1766.16	7.39	43.44
45.0-50.0	298.41	2064.57	7.34	50.78
50.0-55.0	287.93	2352.50	7.08	57.86
55.0-60.0	269.48	2621.98	6.63	64.49
60.0-65.0	243.84	2865.82	6.00	70.48
65.0-70.0	212.03	3077.85	5.21	75.70
70.0-75.0	175.67	3253.52	4.32	80.02
75.0-80.0	137.73	3391.25	3.39	83.41
80.0-85.0	103.27	3494.52	2.54	85.95
85.0-90.0	79.29	3573.81	1.95	87.90
90.0-95.0	67.62	3641.43	1.66	89.56
95.0-100.0	61.95	3703.39	1.52	91.08
100.0-105.0	57.09	3760.47	1.40	92.49
105.0-110.0	51.38	3811.86	1.26	93.75
110.0-115.0	45.28	3857.14	1.11	94.87
115.0-120.0	39.96	3897.10	0.98	95.85
120.0-125.0	34.90	3931.99	0.86	96.71
125.0-130.0	29.50	3961.49	0.73	97.43
130.0-135.0	24.87	3986.37	0.61	98.04
135.0-140.0	21.00	4007.37	0.52	98.56
140.0-145.0	17.14	4024.50	0.42	98.98
145.0-150.0	13.57	4038.08	0.33	99.32
150.0-155.0	10.27	4048.35	0.25	99.57
155.0-160.0	7.41	4055.75	0.18	99.75
160.0-165.0	5.04	4060.79	0.12	99.87
165.0-170.0	3.10	4063.89	0.08	99.95
170.0-175.0	1.57	4065.46	0.04	99.99
175.0-180.0	0.45	4065.91	0.01	100.00

---

# IES Indoor Report

Photometric Filename: B36W-CC-E-4K-2019-10-28.IES

## Rectangle ISO Lighting Intensity Diagram

Lum. Name: B36W-CC-E	Lum. Catalog: LED BATTEN	Test ID:
Lamp Name: 4000K	Lamp Catalog: SMD2835	Test Lab:
Manufacture:	Test Machine: GON-2000	Test Date: 2019/10/28

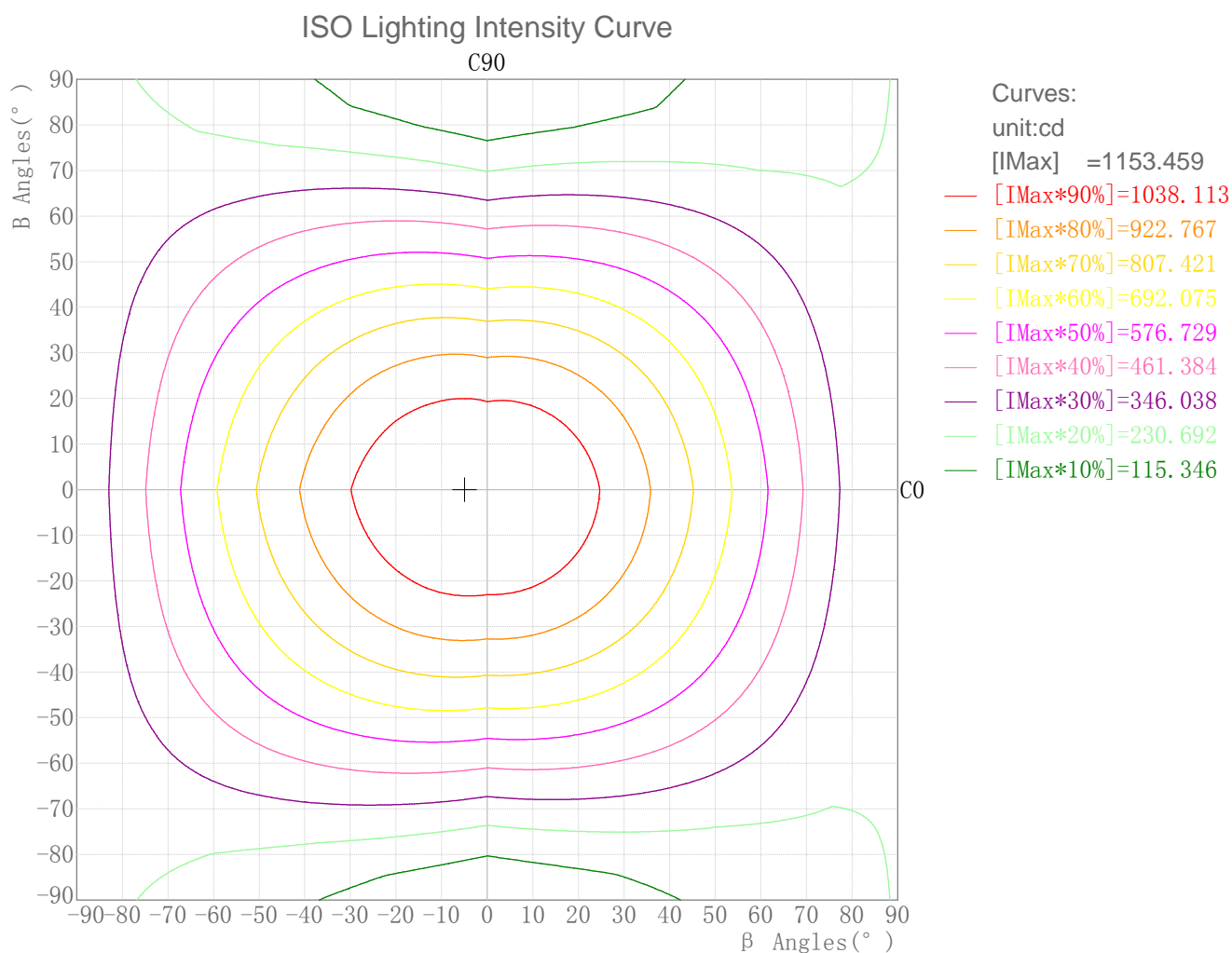

# IES Indoor Report

Photometric Filename: B36W-CC-E-4K-2019-10-28.IES

## Plane ISO-Illuminance Diagram

Lum. Name: B36W-CC-E	Lum. Catalog: LED BATTEN	Test ID:
Lamp Name: 4000K	Lamp Catalog: SMD2835	Test Lab:
Manufacture:	Test Machine: GON-2000	Test Date: 2019/10/28

### Plane ISO-Illuminance Curve

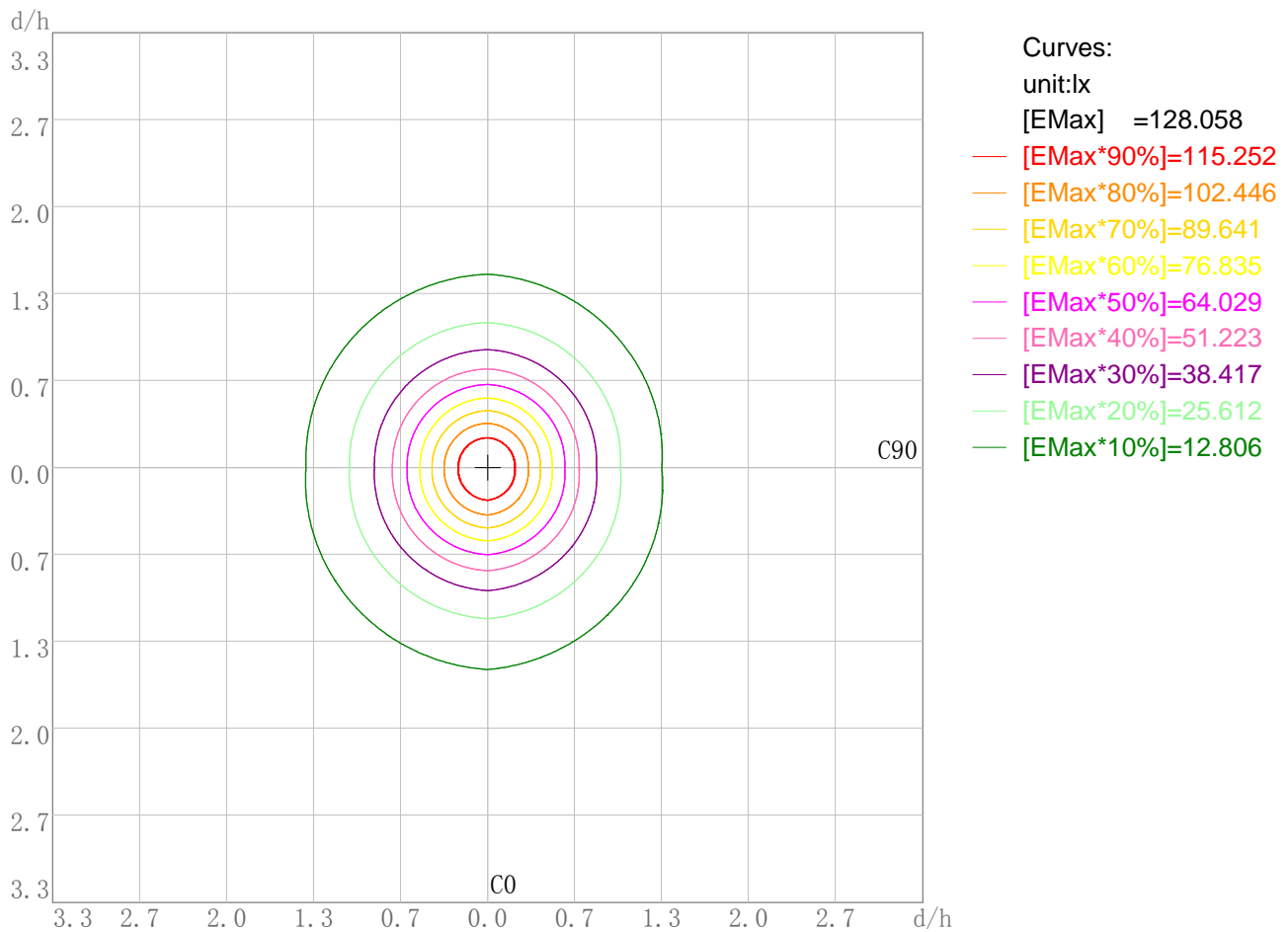

Working Plane Luminaire Mounting Height(m): 3.00

Working Plane Maximum Illuminance(lx): 128.06

Working Plane Maximum Illuminance Position(d/h): H0.0 V0.0

# IES Indoor Report

Photometric Filename: B36W-CC-E-4K-2019-10-28.IES

---

## 3D Plane ISO Illuminance Diagram

Lum. Name: B36W-CC-E	Lum. Catalog: LED BATTEN	Test ID:
Lamp Name: 4000K	Lamp Catalog: SMD2835	Test Lab:
Manufacture:	Test Machine: GON-2000	Test Date: 2019/10/28

### 3D Plane Illuminance Modal

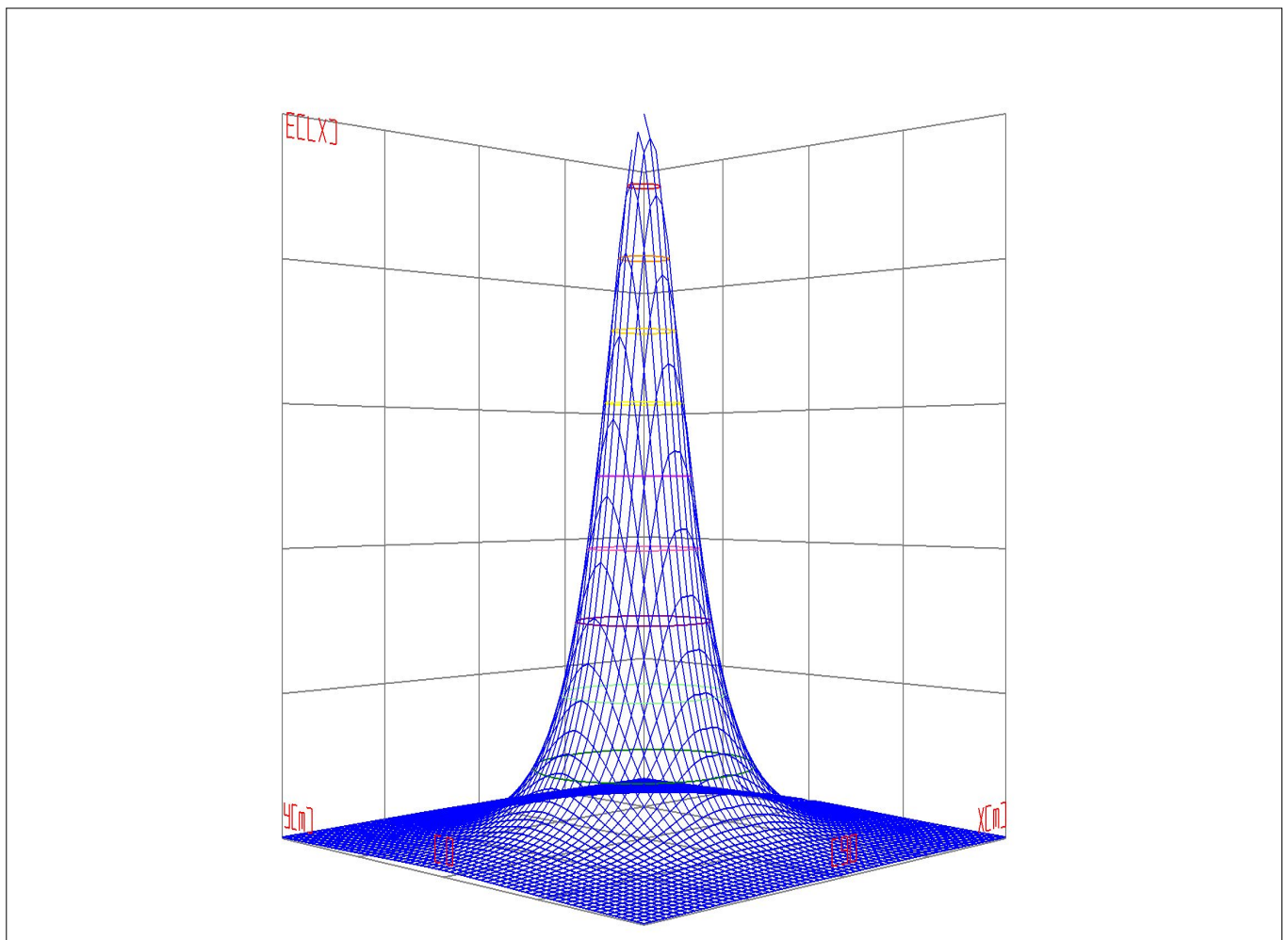

Curves: 3D Model — 90% — 80% — 70% — 60% — 50% — 40% — 30% — 20% — 10% —  
View Angles(deg): 0    Height(m): 3.0    Distance(m): 10.0

---

# IES Indoor Report

Photometric Filename: B36W-CC-E-4K-2019-10-28.IES

---

## Space ISO Illuminance Diagram

Lum. Name: B36W-CC-E	Lum. Catalog: LED BATTEN	Test ID:
Lamp Name: 4000K	Lamp Catalog: SMD2835	Test Lab:
Manufacture:	Test Machine: GON-2000	Test Date: 2019/10/28

### Space ISO Illuminance Curve

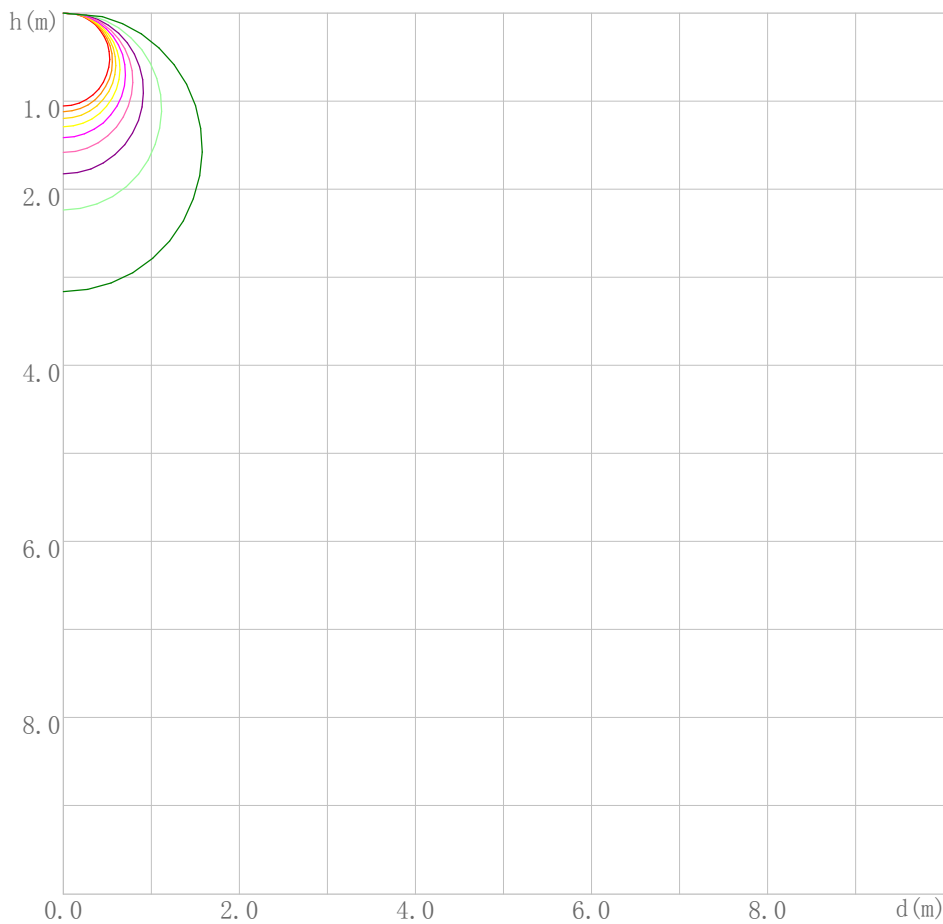

- Curves:  
unit: lx  
[EMax] = 1152.523  
— [EMax\*90%]=1037.271  
— [EMax\*80%]=922.018  
— [EMax\*70%]=806.766  
— [EMax\*60%]=691.514  
— [EMax\*50%]=576.261  
— [EMax\*40%]=461.009  
— [EMax\*30%]=345.757  
— [EMax\*20%]=230.505  
— [EMax\*10%]=115.252

Space Plane Maximum Illuminance and @Angle: 1152.52, 0.0deg  
Plane Maximum Lighting Intensity and @Angle: 1152.523cd, 0deg

---

# IES Indoor Report

Photometric Filename: B36W-CC-E-4K-2019-10-28.IES

---

## Illuminance-Distance Diagram

Lum. Name: B36W-CC-E	Lum. Catalog: LED BATTEN	Test ID:
Lamp Name: 4000K	Lamp Catalog: SMD2835	Test Lab:
Manufacture:	Test Machine: GON-2000	Test Date: 2019/10/28

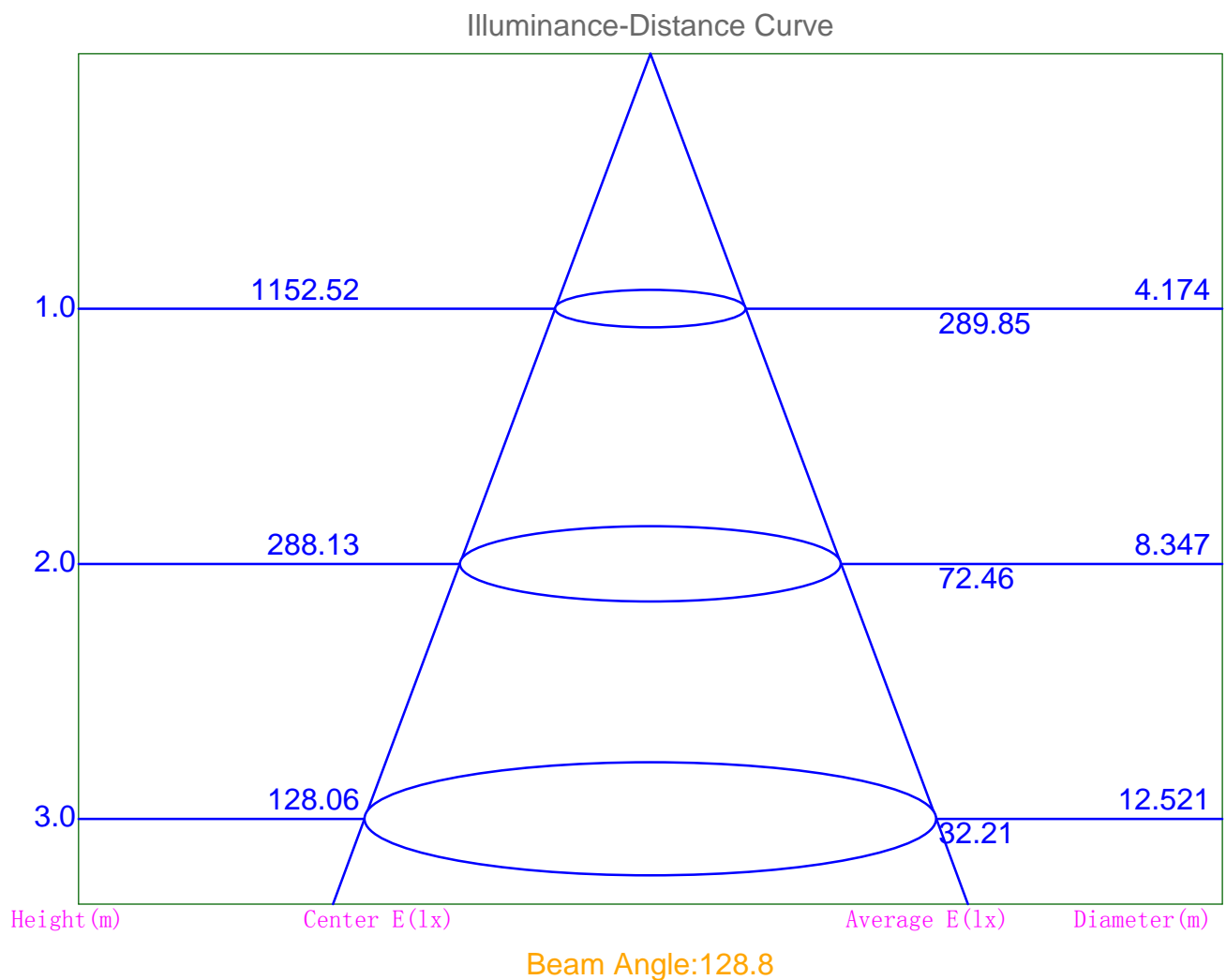



# IES Indoor Report

Photometric Filename: B36W-CC-E-4K-2019-10-28.IES

## Indoor Luminance Limiting Curves

Lum. Name: B36W-CC-E	Lum. Catalog: LED BATTEN	Test ID:
Lamp Name: 4000K	Lamp Catalog: SMD2835	Test Lab:
Manufacture:	Test Machine: GON-2000	Test Date: 2019/10/28

Glare Grade Table

GI	Quality	Using Illuminance							
		a	b	c	d	e	f	g	h
1.15	A	2000	1000	500	<=300				
1.5	B		2000	1000	500	<=300			
1.85	C			2000	1000	500	<=300		
2.2	D				2000	1000	500	<=300	
2.55	E	a				2000	1000	500	<=300
			b	c	d	e	f	g	h

Luminance Table

Gama (deg)	45	50	55	60	65	70	75	80	85
C0	7638	7708	7823	8003	8290	8772	9693	11928	20108
C90	6374	6116	5818	5460	5012	4409	3578	2408	914

Luminance Limiting Curve

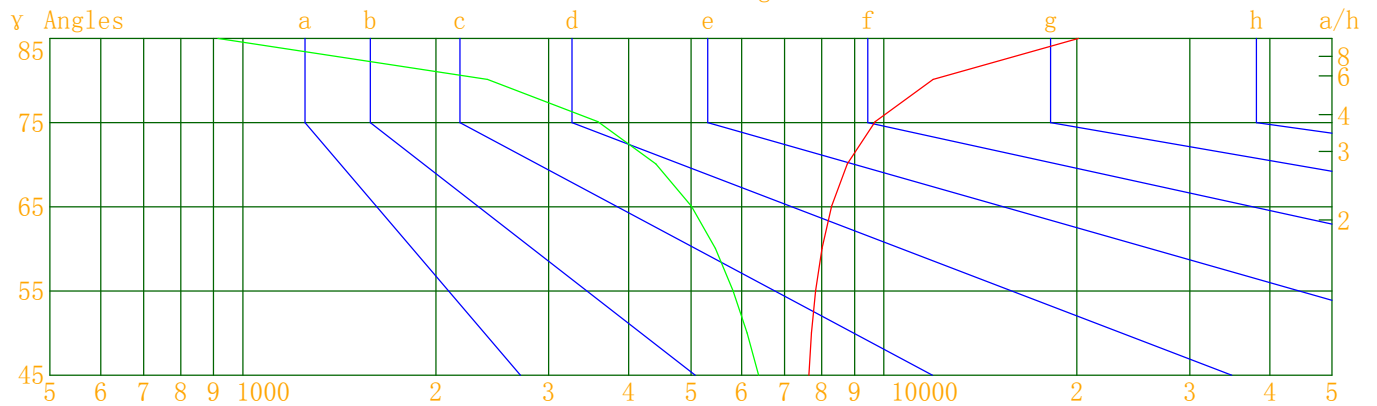

Luminous Size: Length(m)=1.200 Width(m)=0.060 Height(m)=0.065 Area(m^2)=0.150000  
 Luminous Type: Without Luminous Side  
 Luminous Curves: C0-C180 Color: — C90-C270 Color: —

# IES Indoor Report

Photometric Filename: B36W-CC-E-4K-2019-10-28.IES

## Indoor Budgetary Estimate Table

Lum. Name: B36W-CC-E	Lum. Catalog: LED BATTEN	Test ID:
Lamp Name: 4000K	Lamp Catalog: SMD2835	Test Lab:
Manufacture:	Test Machine: GON-2000	Test Date: 2019/10/28

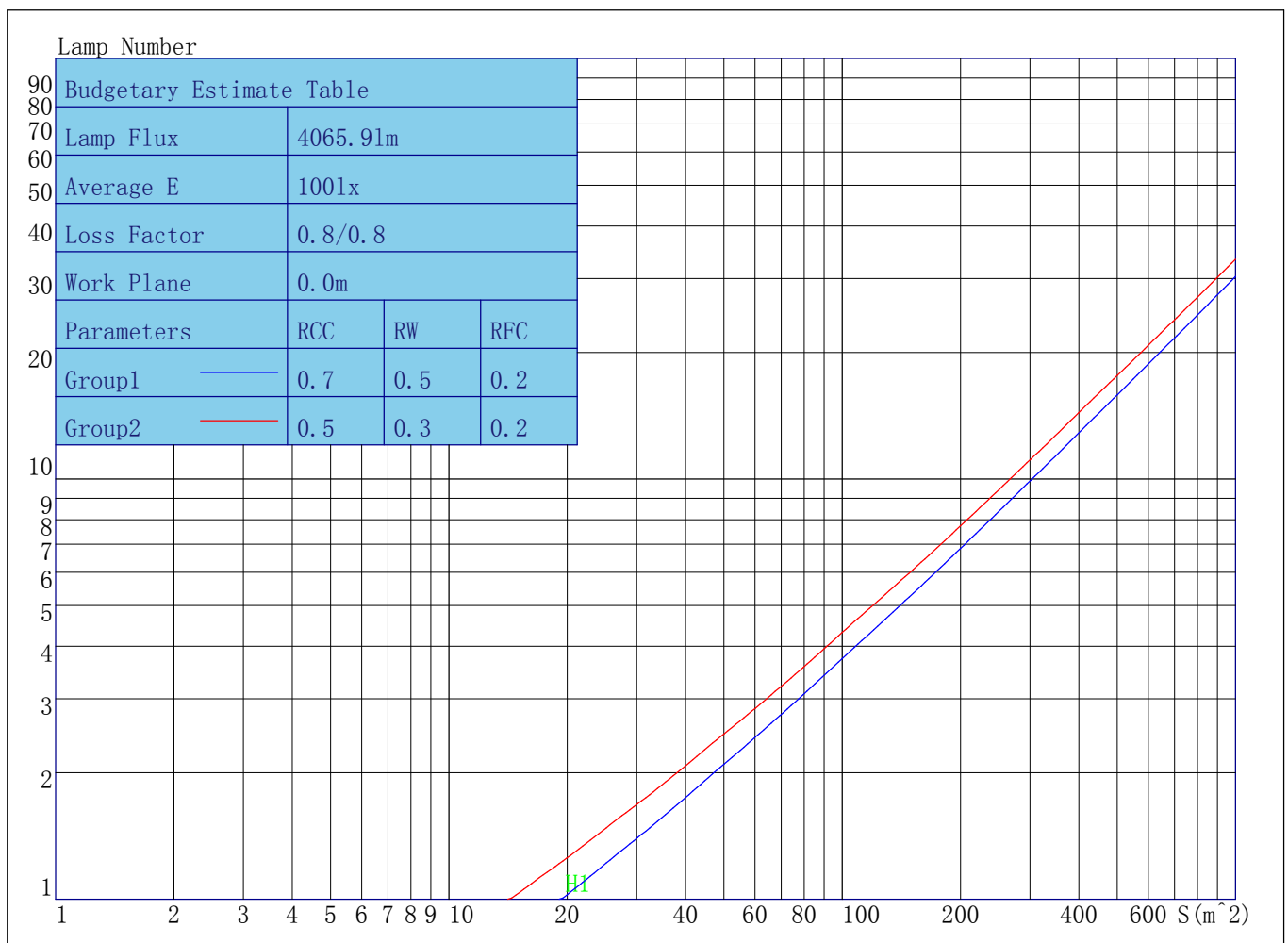

Parameters1: Rhocc = 0.7 Rhow = 0.5 Rhofc = 0.2 LLF = 0.8  
 Parameters2: Rhocc = 0.5 Rhow = 0.3 Rhofc = 0.2 LLF = 0.8  
 Average Illuminance(lx): 100 Cavity Height: H1(m) = 2

# IES Indoor Report

Photometric Filename: B36W-CC-E-4K-2019-10-28.IES

## Indoor Coefficient of Utilization Table

Lum. Name: B36W-CC-E	Lum. Catalog: LED BATTEN	Test ID:
Lamp Name: 4000K	Lamp Catalog: SMD2835	Test Lab:
Manufacture:	Test Machine: GON-2000	Test Date: 2019/10/28

Coefficients of Utilization - Zonal Cavity Method																		
Coef.	Effective Floor Cavity Reflectance RFC=0.20																	
RhoCC (%)	80				70				50			30			10			0
RhoW (%)	70	50	30	10	70	50	30	10	50	30	10	50	30	10	50	30	10	0
RCR	Coefficient of Utilization (%)																	
0	116	116	116	116	112	112	112	112	104	104	104	97	97	97	91	91	91	88
1	105	99	95	90	101	96	92	88	89	86	83	83	81	78	78	76	74	71
2	95	86	79	73	91	83	76	71	77	72	67	72	68	64	68	64	61	58
3	86	75	67	60	82	72	65	58	68	61	56	63	58	53	59	55	51	48
4	79	66	57	50	75	64	56	49	60	53	47	56	50	45	53	48	43	41
5	72	59	50	43	69	57	49	42	54	46	41	50	44	39	47	42	38	35
6	66	53	44	37	64	51	43	37	48	41	35	46	39	34	43	37	33	31
7	62	48	39	33	59	47	38	32	44	37	31	41	35	30	39	33	29	27
8	57	44	35	29	55	42	34	29	40	33	28	38	32	27	36	30	26	24
9	53	40	32	26	51	39	31	26	37	30	25	35	29	24	33	28	24	22
10	50	37	29	24	48	36	28	23	34	27	23	32	26	22	31	25	21	20

# IES Indoor Report

Photometric Filename: B36W-CC-E-4K-2019-10-28.IES

## Unified Glare Rating Table

Lum. Name: B36W-CC-E	Lum. Catalog: LED BATTEN	Test ID:
Lamp Name: 4000K	Lamp Catalog: SMD2835	Test Lab:
Manufacture:	Test Machine: GON-2000	Test Date: 2019/10/28

## Unified Glare Rating Table

Ceiling RCC	0.70	0.70	0.50	0.50	0.30	0.70	0.70	0.50	0.50	0.30
Wall RW	0.50	0.30	0.50	0.30	0.30	0.50	0.30	0.50	0.30	0.30
Floor RFC	0.20	0.20	0.20	0.20	0.20	0.20	0.20	0.20	0.20	0.20
Room Size	Viewed crosswise					Viewed endwise				
X=2H Y=2H	17.2	20.5	18.5	21.8	23.1	15.4	18.7	16.7	20.0	21.3
Y=3H	23.1	26.3	24.3	27.6	28.9	19.3	22.6	20.6	23.9	25.2
Y=4H	26.8	29.7	28.1	31.0	32.3	21.5	24.4	22.8	25.7	27.0
Y=6H	30.2	33.0	31.5	34.3	35.7	22.6	25.4	23.9	26.7	28.0
Y=8H	32.1	34.9	33.4	36.2	37.6	22.8	25.6	24.2	27.0	28.3
Y=12H	34.3	37.1	35.6	38.4	39.7	23.0	25.7	24.3	27.1	28.4
X=4H Y=2H	18.4	21.3	19.7	22.6	23.9	17.6	20.5	18.9	21.8	23.2
Y=3H	24.5	27.4	25.8	28.7	30.0	21.9	24.8	23.2	26.1	27.5
Y=4H	26.7	28.5	28.3	30.1	31.7	22.7	24.5	24.3	26.1	27.6
Y=6H	30.7	32.4	32.4	34.0	35.6	24.4	26.1	26.0	27.7	29.2
Y=8H	33.1	34.7	34.7	36.3	37.8	25.0	26.6	26.6	28.2	29.8
Y=12H	34.9	36.2	36.6	37.9	39.6	24.5	25.8	26.2	27.5	29.2
X=8H Y=4H	27.0	28.6	28.6	30.2	31.8	23.8	25.4	25.4	27.0	28.6
Y=6H	30.5	31.7	32.2	33.4	35.1	25.3	26.4	27.0	28.1	29.8
Y=8H	32.6	33.6	34.5	35.4	37.1	25.8	26.8	27.7	28.6	30.3
Y=12H	35.9	36.7	37.7	38.5	40.3	26.7	27.6	28.6	29.4	31.2
X=12H Y=4H	26.1	27.4	27.8	29.1	30.8	23.2	24.6	24.9	26.3	27.9
Y=6H	30.0	31.0	31.9	32.8	34.6	25.3	26.2	27.1	28.0	29.8
Y=8H	32.7	33.6	34.6	35.4	37.2	26.6	27.4	28.4	29.2	31.0
Variations with the observer position at spacings										
S=1.0H	2.1/-2.0					2.4/-0.2				
S=1.5H	-2.0/-20.6					-0.2/-16.6				
S=2.0H	-2.0/-20.6					-0.2/-16.6				

# IES Indoor Report

Photometric Filename: B36W-CC-E-4K-2019-10-28.IES

---

## Candela Tabulation

V/H	C0.0	C90.0	C180.0	C270.0
Y 0.0	1152.52	1152.52	1152.52	1152.52
Y 5.0	1146.94	1139.16	1153.46	1148.87
Y 10.0	1132.75	1115.00	1147.20	1134.23
Y 15.0	1109.35	1078.91	1133.16	1107.08
Y 20.0	1076.55	1031.65	1110.05	1068.11
Y 25.0	1035.44	974.62	1077.80	1018.34
Y 30.0	986.93	909.22	1037.09	959.21
Y 35.0	932.44	836.90	989.28	892.14
Y 40.0	873.37	758.70	935.89	818.39
Y 45.0	810.17	676.11	877.59	739.25
Y 50.0	743.23	589.67	815.56	655.67
Y 55.0	673.08	500.57	750.30	568.75
Y 60.0	600.19	409.53	681.49	479.47
Y 65.0	525.52	317.69	609.80	388.44
Y 70.0	450.03	226.20	535.37	296.43
Y 75.0	376.32	138.93	459.43	205.60
Y 80.0	310.69	62.73	385.39	119.89
Y 85.0	262.88	11.95	318.75	47.98
Y 90.0	234.99	4.10	268.90	8.73
Y 95.0	219.47	4.82	239.87	7.02
Y 100.0	204.96	5.61	223.00	7.28
Y 105.0	190.98	6.32	207.72	7.55
Y 110.0	169.74	7.11	188.79	8.14
Y 115.0	156.33	7.86	168.46	8.86
Y 120.0	142.76	8.60	155.21	9.42
Y 125.0	128.42	9.38	140.02	10.08
Y 130.0	108.65	10.05	125.43	10.64
Y 135.0	102.60	10.85	112.88	11.30
Y 140.0	91.30	11.68	101.04	11.96
Y 145.0	80.05	12.51	89.64	12.70
Y 150.0	68.53	13.41	78.42	13.41
Y 155.0	56.80	14.19	65.64	14.27
Y 160.0	46.17	14.95	55.28	15.13
Y 165.0	36.58	15.57	45.28	15.76
Y 170.0	27.72	16.12	35.71	16.24
Y 175.0	19.82	16.45	26.98	16.59
Y 180.0	17.47	17.47	17.47	17.47

---