

Indoor Luminaire Photometric Data

Description Information

Lum. Name: B20W-CC-MS	Lum. Catalog: LED BATTEN	Test ID:
Lamp Name: 6000K	Lamp Catalog: SMD2835	Test Date: 2018/10/27
Manufacture:	ShldAngle(°):	Test Machine: GON-2000
Test Lab:	Frequency (Hz):	Lamp CCT (K): Ra:
Lum. Size (W*L*H): 0.080m*0.600m*0.065m	Lum. Area (m2): 0.087	Lum. W (kg): 2.000
Test System: C, γ	Test Step: C=90.0 γ=5.0	Temp. (°C): 25
		Humidity (%):

Character Parameter

Lamp Speciality Parameter	Luminaire Speciality Parameter	
Rated Flux (lm): 1686.380	Luminaire Flux: 1686.376lm	Field Angle (10%Imax): 252.7
Rated Power (W):	Luminaire Efficiency: 100.00%	Down Lumens&Percent: 1499.510lm 88.92%
Rated Voltage (V):	Luminaire EER (lm/W): 91.106	Up Lumens&Percent: 186.866lm 11.08%
Tested Power (W): 18.510	Max. Cand. (cd): 462.342	S/MH: C0_a180=1.351 C90_270=1.254
Lamps' Inside: 1	Max Cand@Ang. (°): C=180.0 γ=5.0	CIE Type: General Diffuse
Tested Electric: U=241.0V, I=0.082A, PF=0.000	Beam Angle (50%Imax): 131.0	ErP Φ use (120°): 1093.401lm
Lamp Size (W*L*H): 0.080m*0.600m*0.065m	Left=-68.5 Right=62.5	IRF: 100.933%

Lighting Distribution Diagram

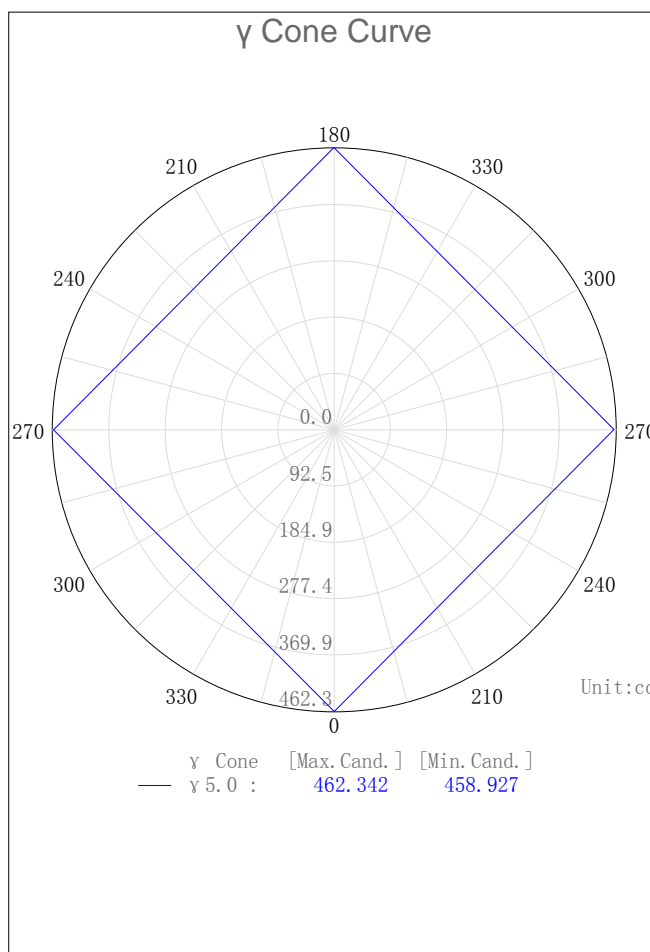
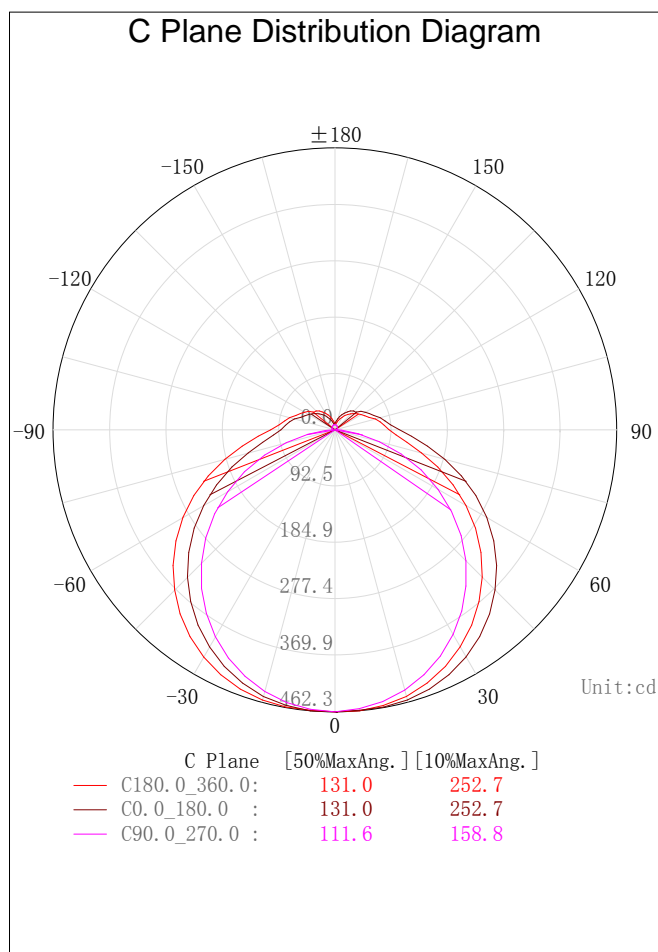

3D Light Intensity Distribution Modal

Lum. Name: B20W-CC-MS	Lum. Catalog: LED BATTEN	Test ID:
Lamp Name: 6000K	Lamp Catalog: SMD2835	Test Lab:
Manufacture:	Test Machine: GON-2000	Test Date: 2018/10/27

3D Light Intensity Distribution Modal

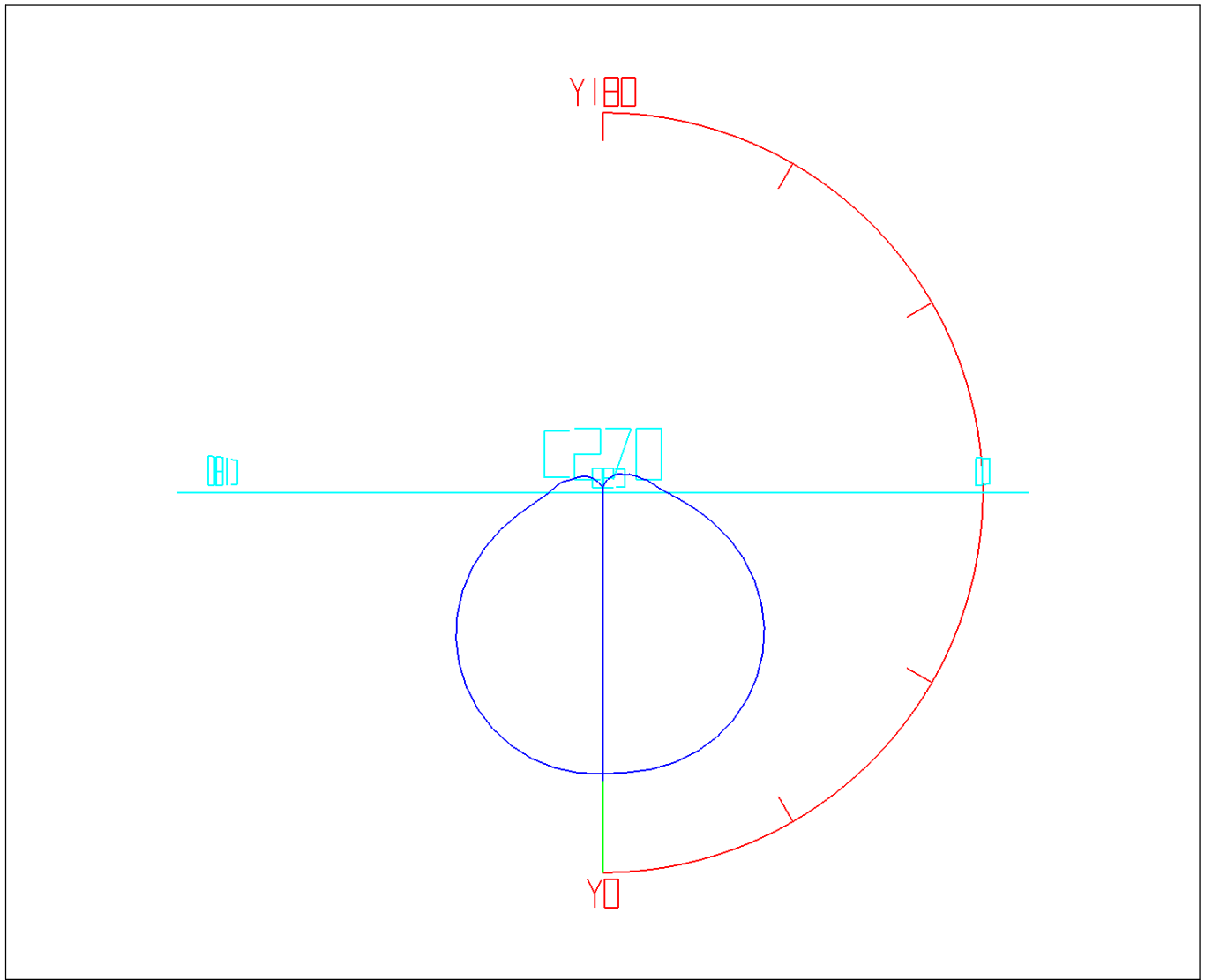

Curves: 3D Model — Fixture — Vert. HUD — Hori. HUD —
 View Angles: Orient:0 Tilt:0 Roll:0 Spin:0

Zonal Flux Tabulation

Zone (y)	Zone Flux (lm)	Sums Flux (lm)	Zone%Lamp	Sums%Lamp
0.0-5.0	11.03	11.03	0.65	0.65
5.0-10.0	32.82	43.85	1.95	2.60
10.0-15.0	53.74	97.59	3.19	5.79
15.0-20.0	73.13	170.72	4.34	10.12
20.0-25.0	90.34	261.06	5.36	15.48
25.0-30.0	104.83	365.89	6.22	21.70
30.0-35.0	116.13	482.01	6.89	28.58
35.0-40.0	123.88	605.90	7.35	35.93
40.0-45.0	127.82	733.72	7.58	43.51
45.0-50.0	127.81	861.53	7.58	51.09
50.0-55.0	123.82	985.35	7.34	58.43
55.0-60.0	115.98	1101.33	6.88	65.31
60.0-65.0	104.63	1205.96	6.20	71.51
65.0-70.0	90.27	1296.23	5.35	76.86
70.0-75.0	73.79	1370.02	4.38	81.24
75.0-80.0	56.80	1426.82	3.37	84.61
80.0-85.0	41.55	1468.37	2.46	87.07
85.0-90.0	31.14	1499.51	1.85	88.92
90.0-95.0	26.08	1525.59	1.55	90.47
95.0-100.0	23.51	1549.10	1.39	91.86
100.0-105.0	21.38	1570.49	1.27	93.13
105.0-110.0	18.92	1589.40	1.12	94.25
110.0-115.0	16.58	1605.99	0.98	95.23
115.0-120.0	14.74	1620.73	0.87	96.11
120.0-125.0	13.00	1633.73	0.77	96.88
125.0-130.0	11.18	1644.91	0.66	97.54
130.0-135.0	9.59	1654.50	0.57	98.11
135.0-140.0	8.24	1662.74	0.49	98.60
140.0-145.0	6.81	1669.55	0.40	99.00
145.0-150.0	5.38	1674.93	0.32	99.32
150.0-155.0	4.10	1679.03	0.24	99.56
155.0-160.0	3.02	1682.05	0.18	99.74
160.0-165.0	2.09	1684.14	0.12	99.87
165.0-170.0	1.32	1685.46	0.08	99.95
170.0-175.0	0.70	1686.16	0.04	99.99
175.0-180.0	0.21	1686.38	0.01	100.00

Rectangle ISO Lighting Intensity Diagram

Lum. Name: B20W-CC-MS	Lum. Catalog: LED BATTEN	Test ID:
Lamp Name: 6000K	Lamp Catalog: SMD2835	Test Lab:
Manufacture:	Test Machine: GON-2000	Test Date: 2018/10/27

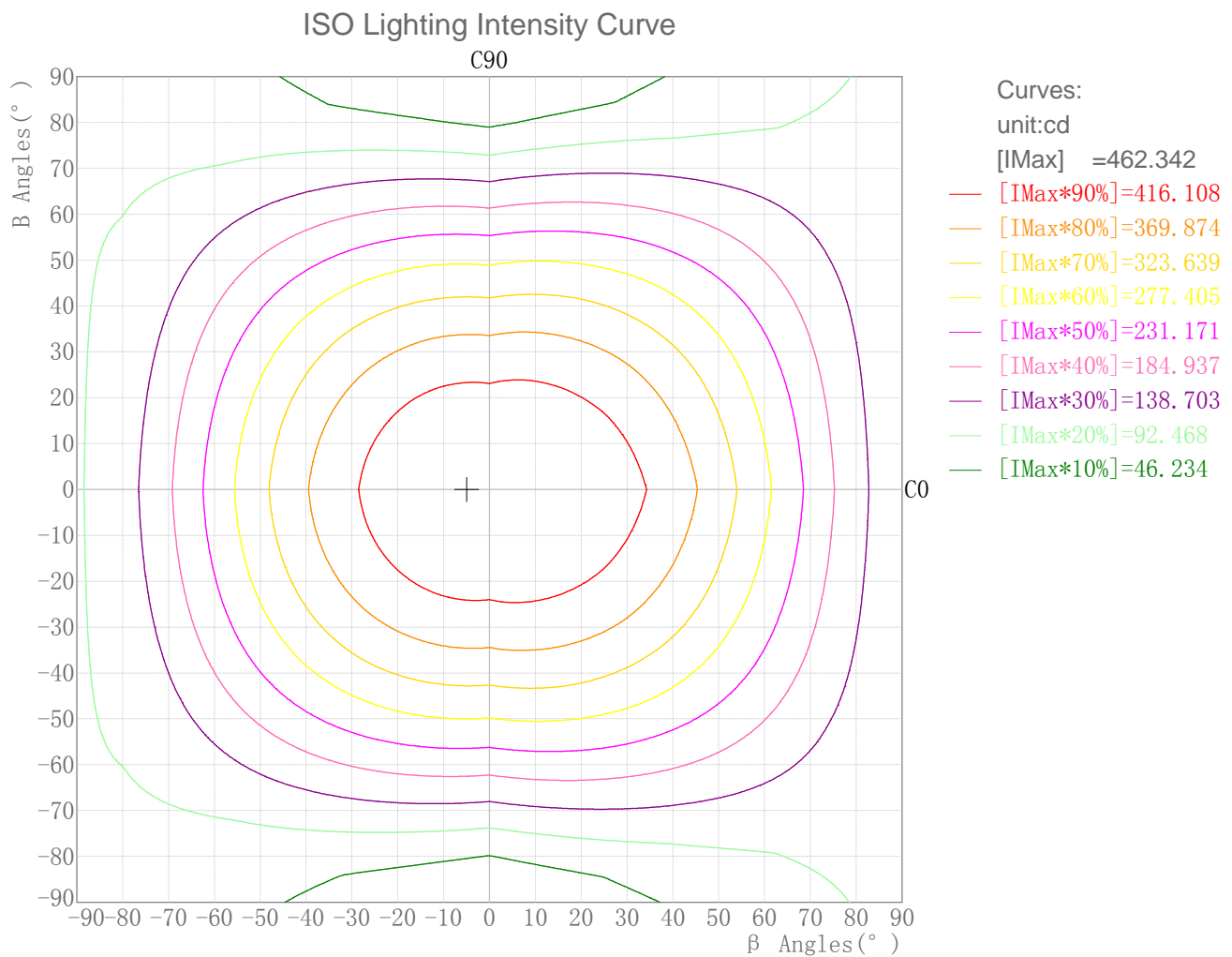

Maximum Light Intensity(cd): 462.34
Maximum Cand.@Angle: H=-5.0°;V=0.0°

Plane ISO-Illuminance Diagram

Lum. Name: B20W-CC-MS	Lum. Catalog: LED BATTEN	Test ID:
Lamp Name: 6000K	Lamp Catalog: SMD2835	Test Lab:
Manufacture:	Test Machine: GON-2000	Test Date: 2018/10/27

Plane ISO-Illuminance Curve

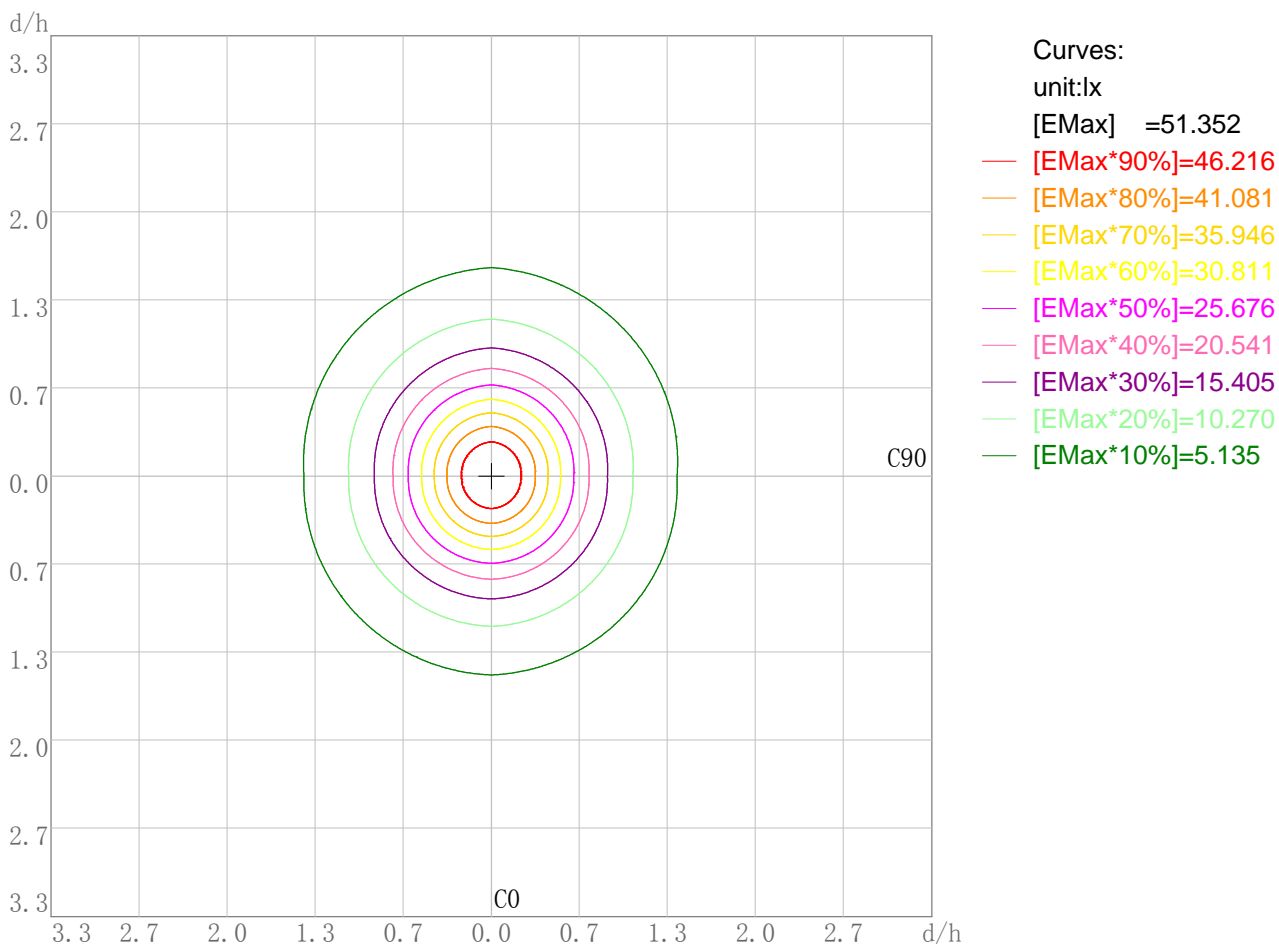

Working Plane Luminaire Mounting Height(m): 3.00
 Working Plane Maximum Illuminance(lx): 51.35
 Working Plane Maximum Illuminance Position(d/h): H0.0 V0.0

3D Plane ISO Illuminance Diagram

Lum. Name: B20W-CC-MS	Lum. Catalog: LED BATTEN	Test ID:
Lamp Name: 6000K	Lamp Catalog: SMD2835	Test Lab:
Manufacture:	Test Machine: GON-2000	Test Date: 2018/10/27

3D Plane Illuminance Modal

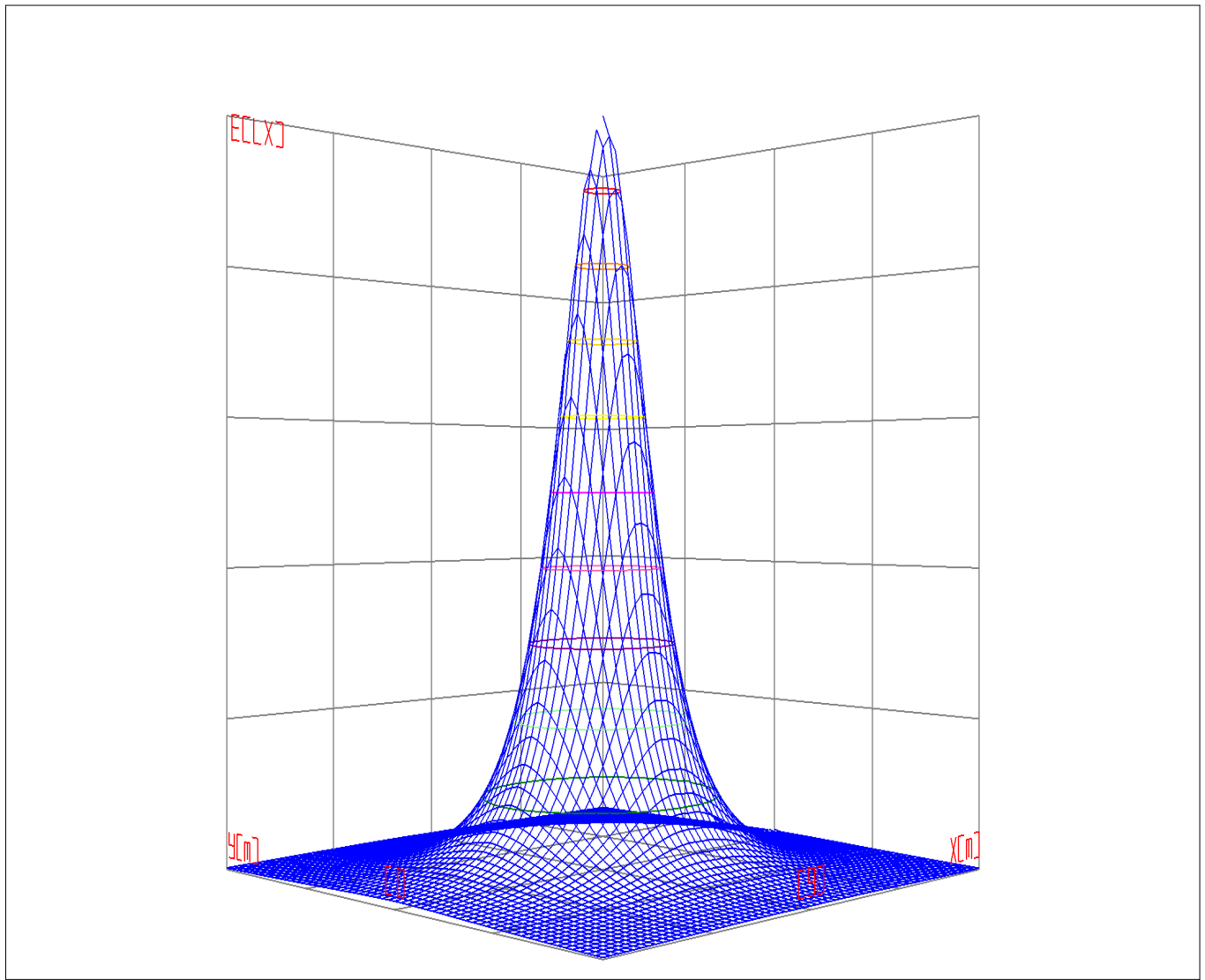

Curves: 3D Model — 90% — 80% — 70% — 60% — 50% — 40% — 30% — 20% — 10% —
View Angles(deg): 0 Height(m): 3.0 Distance(m): 10.0

Space ISO Illuminance Diagram

Lum. Name: B20W-CC-MS	Lum. Catalog: LED BATTEN	Test ID:
Lamp Name: 6000K	Lamp Catalog: SMD2835	Test Lab:
Manufacture:	Test Machine: GON-2000	Test Date: 2018/10/27

Space ISO Illuminance Curve

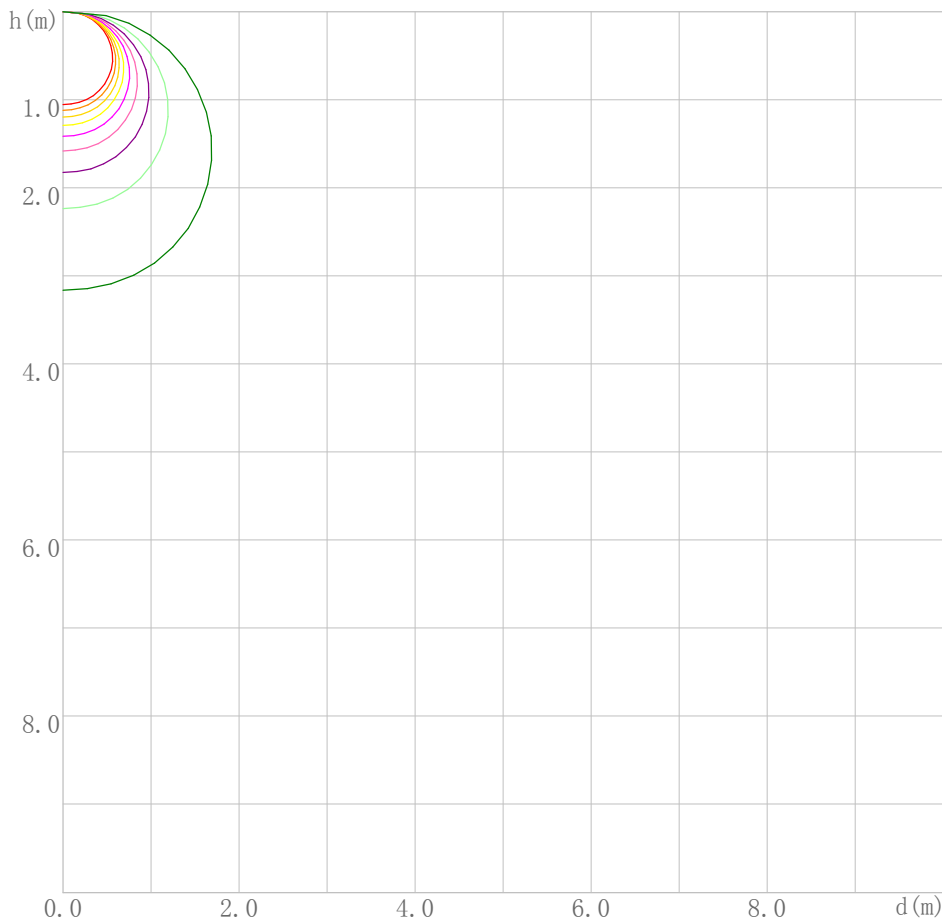

- Curves:
unit:lx
[E_{Max}] =462.165
- [E_{Max}*90%]=415.949
 - [E_{Max}*80%]=369.732
 - [E_{Max}*70%]=323.516
 - [E_{Max}*60%]=277.299
 - [E_{Max}*50%]=231.083
 - [E_{Max}*40%]=184.866
 - [E_{Max}*30%]=138.650
 - [E_{Max}*20%]=92.433
 - [E_{Max}*10%]=46.217

Space Plane Maximum Illuminance and @Angle:462.17,0.0deg
Plane Maximum Lighting Intensity and @Angle:462.165cd,0deg

Illuminance-Distance Diagram

Lum. Name: B20W-CC-MS	Lum. Catalog: LED BATTEN	Test ID:
Lamp Name: 6000K	Lamp Catalog: SMD2835	Test Lab:
Manufacture:	Test Machine: GON-2000	Test Date: 2018/10/27

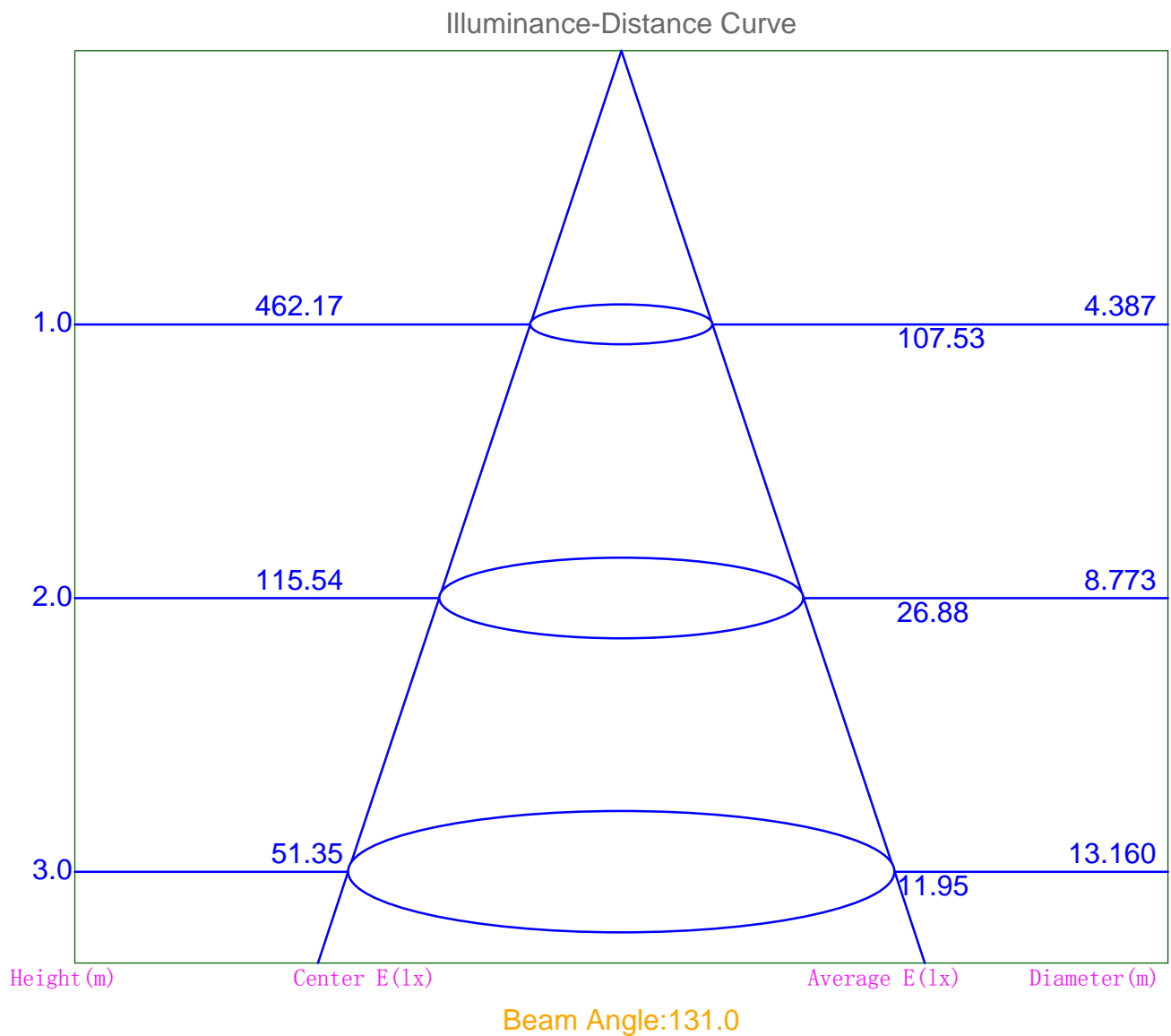

Indoor Luminance Limiting Curves

Lum. Name: B20W-CC-MS	Lum. Catalog: LED BATTEN	Test ID:
Lamp Name: 6000K	Lamp Catalog: SMD2835	Test Lab:
Manufacture:	Test Machine: GON-2000	Test Date: 2018/10/27

Glare Grade Table

GI	Quality	Using Illuminance							
		a	b	c	d	e	f	g	h
1.15	A	2000	1000	500	<=300				
1.5	B		2000	1000	500	<=300			
1.85	C			2000	1000	500	<=300		
2.2	D				2000	1000	500	<=300	
2.55	E	a				2000	1000	500	<=300
			b	c	d	e	f	g	h

Luminance Table

Gama (deg)	45	50	55	60	65	70	75	80	85
C0	6040	6189	6370	6605	6932	7428	8287	10198	16638
C90	4933	4824	4683	4495	4241	3873	3343	2569	1470

Luminance Limiting Curve

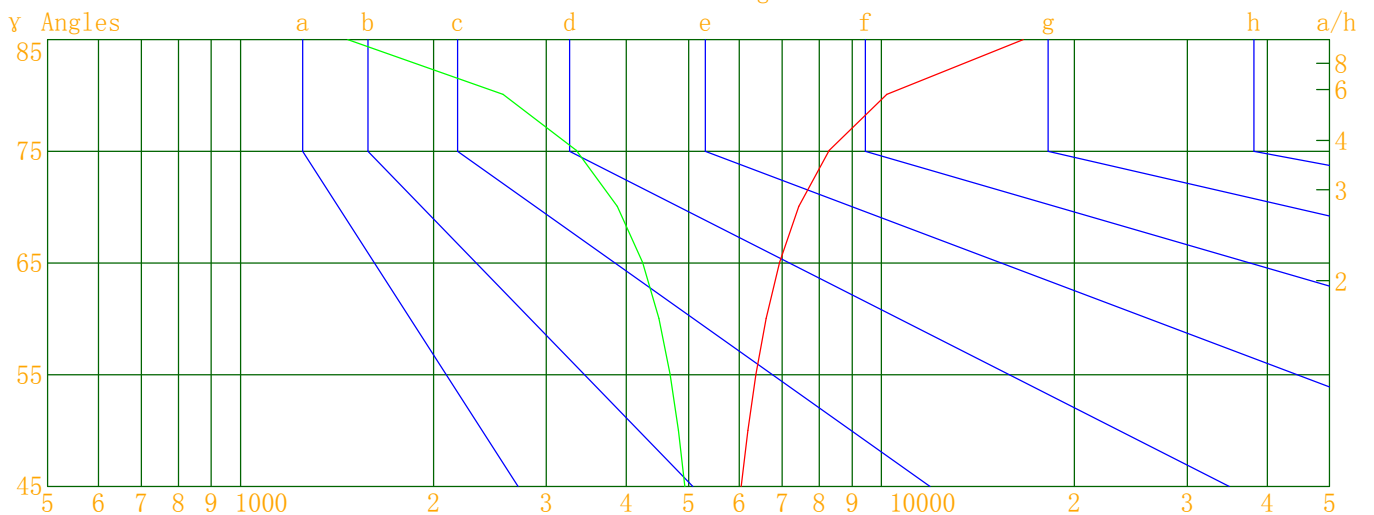

Luminous Size: Length(m)=0.600 Width(m)=0.080 Height(m)=0.065 Area(m²)=0.087000
 Luminous Type: Without Luminous Side
 Luminous Curves: C0-C180 Color: ——— C90-C270 Color: ———

Indoor Budgetary Estimate Table

Lum. Name: B20W-CC-MS	Lum. Catalog: LED BATTEN	Test ID:
Lamp Name: 6000K	Lamp Catalog: SMD2835	Test Lab:
Manufacture:	Test Machine: GON-2000	Test Date: 2018/10/27

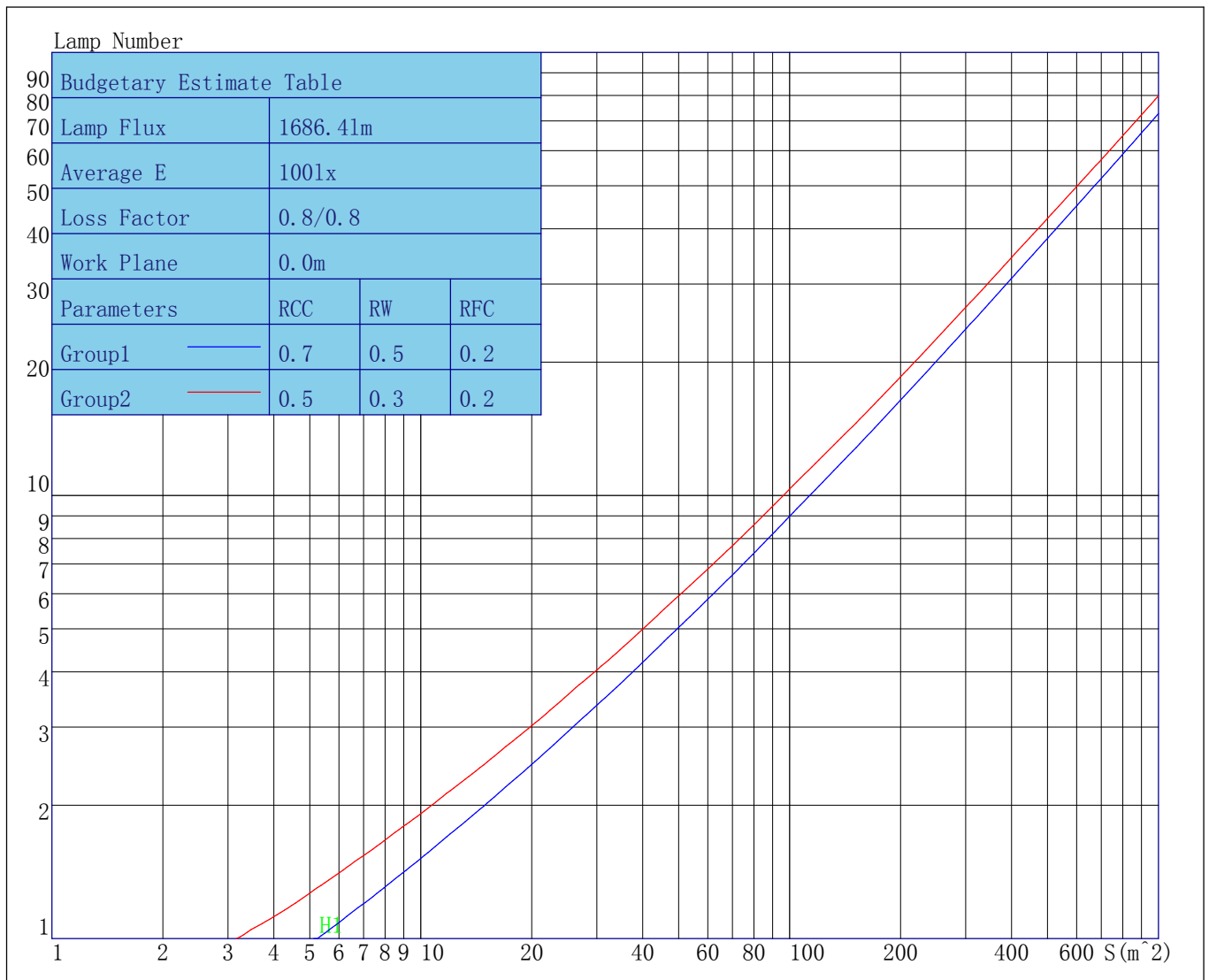

Parameters1: Rhocc = 0.7 Rhow = 0.5 Rhofc = 0.2 LLF = 0.8
 Parameters2: Rhocc = 0.5 Rhow = 0.3 Rhofc = 0.2 LLF = 0.8
 Average Illuminance(lx): 100 Cavity Height: H1(m) = 2

Indoor Coefficient of Utilization Table

Lum. Name: B20W-CC-MS	Lum. Catalog: LED BATTEN	Test ID:
Lamp Name: 6000K	Lamp Catalog: SMD2835	Test Lab:
Manufacture:	Test Machine: GON-2000	Test Date: 2018/10/27

Coefficients of Utilization - Zonal Cavity Method																		
Coef.	Effective Floor Cavity Reflectance RFC=0.20																	
RhoCC (%)	80				70				50			30			10			0
RhoW (%)	70	50	30	10	70	50	30	10	50	30	10	50	30	10	50	30	10	0
RCR	Coefficient of Utilization (%)																	
0	116	116	116	116	112	112	112	112	105	105	105	98	98	98	92	92	92	89
1	105	100	95	91	101	96	92	88	90	86	83	84	81	79	79	76	74	72
2	95	86	79	73	91	83	77	71	78	72	68	73	68	64	68	65	61	59
3	86	75	67	60	83	73	65	58	68	61	56	64	58	54	60	55	51	49
4	79	66	57	50	75	64	56	49	60	53	47	57	50	46	53	48	44	41
5	72	59	50	43	69	57	49	42	54	46	41	51	44	39	48	42	38	35
6	66	53	44	37	64	51	43	37	48	41	35	46	39	34	43	37	33	31
7	62	48	39	33	59	46	38	32	44	37	31	41	35	30	39	34	29	27
8	57	43	35	29	55	42	34	29	40	33	28	38	32	27	36	30	26	24
9	53	40	32	26	51	39	31	26	37	30	25	35	29	24	33	28	23	22
10	50	37	29	23	48	36	28	23	34	27	22	32	26	22	31	25	21	19

Unified Glare Rating Table

Lum. Name: B20W-CC-MS	Lum. Catalog: LED BATTEN	Test ID:
Lamp Name: 6000K	Lamp Catalog: SMD2835	Test Lab:
Manufacture:	Test Machine: GON-2000	Test Date: 2018/10/27

Unified Glare Rating Table

Ceiling RCC	0.70	0.70	0.50	0.50	0.30	0.70	0.70	0.50	0.50	0.30
Wall RW	0.50	0.30	0.50	0.30	0.30	0.50	0.30	0.50	0.30	0.30
Floor RFC	0.20	0.20	0.20	0.20	0.20	0.20	0.20	0.20	0.20	0.20
Room Size	Vewed crosswise					Vewed endwise				
X=2H Y=2H	23.7	27.0	24.9	28.3	29.5	21.8	25.2	23.0	26.4	27.6
Y=3H	29.9	33.2	31.1	34.5	35.7	26.1	29.5	27.4	30.7	32.0
Y=4H	33.8	36.7	35.1	38.0	39.3	28.6	31.5	29.8	32.8	34.0
Y=6H	37.4	40.2	38.6	41.5	42.8	29.9	32.8	31.2	34.1	35.3
Y=8H	39.3	42.1	40.5	43.4	44.7	30.3	33.2	31.6	34.4	35.7
Y=12H	41.4	44.2	42.7	45.5	46.8	30.5	33.4	31.8	34.6	35.9
X=4H Y=2H	25.0	27.9	26.2	29.2	30.5	24.3	27.2	25.5	28.5	29.8
Y=3H	31.4	34.4	32.7	35.6	36.9	28.9	31.8	30.2	33.1	34.4
Y=4H	33.8	35.7	35.4	37.2	38.7	29.9	31.8	31.5	33.3	34.8
Y=6H	38.0	39.7	39.6	41.3	42.8	32.0	33.7	33.5	35.2	36.7
Y=8H	40.4	42.0	42.0	43.5	45.0	32.7	34.3	34.3	35.9	37.4
Y=12H	42.1	43.5	43.8	45.1	46.8	32.3	33.7	34.0	35.3	36.9
X=8H Y=4H	34.2	35.8	35.8	37.4	38.9	31.1	32.7	32.7	34.3	35.8
Y=6H	37.9	39.0	39.6	40.7	42.3	32.9	34.0	34.6	35.7	37.3
Y=8H	40.0	40.9	41.8	42.7	44.4	33.6	34.5	35.4	36.2	37.9
Y=12H	43.1	44.0	44.9	45.8	47.5	34.6	35.4	36.4	37.2	38.9
X=12H Y=4H	33.3	34.7	35.0	36.3	37.9	30.5	31.9	32.2	33.5	35.2
Y=6H	37.4	38.4	39.2	40.1	41.8	32.8	33.8	34.6	35.6	37.2
Y=8H	40.1	41.0	41.9	42.7	44.4	34.3	35.1	36.0	36.9	38.6
Variations with the observer position at spacings										
S=1.0H	2.0/-2.1					2.2/-0.2				
S=1.5H	-2.1/-20.4					-0.2/-16.5				
S=2.0H	-2.1/-20.4					-0.2/-16.5				

IES Indoor Report

Photometric Filename: B20W-CC-MS 6K.IES

Candela Tabulation

V/H	C0.0	C90.0	C180.0	C270.0
Y 0.0	462.17	462.17	462.17	462.17
Y 5.0	461.61	458.93	462.34	459.69
Y 10.0	461.46	452.41	459.08	453.80
Y 15.0	458.77	441.92	452.34	444.01
Y 20.0	452.62	427.49	441.97	430.22
Y 25.0	443.02	409.25	428.20	412.67
Y 30.0	430.01	387.59	411.02	391.61
Y 35.0	413.65	362.67	390.69	367.23
Y 40.0	394.14	334.51	367.37	339.73
Y 45.0	371.59	303.46	341.33	309.25
Y 50.0	346.11	269.80	312.55	276.03
Y 55.0	317.89	233.68	281.44	240.36
Y 60.0	287.30	195.53	248.25	202.62
Y 65.0	254.86	155.92	213.83	163.24
Y 70.0	221.01	115.24	179.21	122.68
Y 75.0	186.59	75.28	146.81	82.45
Y 80.0	154.07	38.80	120.09	44.97
Y 85.0	126.16	11.15	100.94	15.54
Y 90.0	105.38	2.56	88.56	4.62
Y 95.0	91.58	2.85	81.13	4.38
Y 100.0	83.16	3.26	75.32	4.41
Y 105.0	76.67	3.68	68.60	4.54
Y 110.0	67.76	4.13	59.33	4.79
Y 115.0	62.50	4.50	53.97	4.96
Y 120.0	57.03	4.95	49.35	5.31
Y 125.0	52.34	5.32	45.15	5.58
Y 130.0	44.60	5.73	41.09	5.86
Y 135.0	43.33	6.02	36.93	6.20
Y 140.0	39.77	6.41	32.81	6.50
Y 145.0	35.71	6.76	28.51	6.83
Y 150.0	30.97	7.12	23.21	7.11
Y 155.0	26.82	7.41	19.56	7.44
Y 160.0	22.71	7.70	15.69	7.69
Y 165.0	19.00	7.98	12.54	7.99
Y 170.0	15.13	8.21	10.06	8.26
Y 175.0	11.90	8.33	8.34	8.41
Y 180.0	8.69	8.69	8.69	8.69
