

LED CAN DOWNLIGHT



The POWER-LITE® LED Surface Mounted CAN Downlights are designed for surface mounted applications such as concrete slabs & exposed ceilings.

Applications:

Residential, Office, Healthcare, Retail & Commercial.

Specifications

LED Chip:	Citizen COB
Mount Type:	Surface Mount
Warranty:	5 Years
Life Expectancy:	50,000 Hours
Working Temperature:	-20°C to +45°C
CRI:	>80
Power Factor:	>0.90
Beam Angle:	60°
LED Driver:	Dimmable
IP Rating:	IP20
Approvals:	SAA/C-tick (RCM)
Carton Quantity:	24
Voltage:	AC200-240V
Adjustment:	350° Horizontal Swivel 25° Vertical Tilt Gimbal

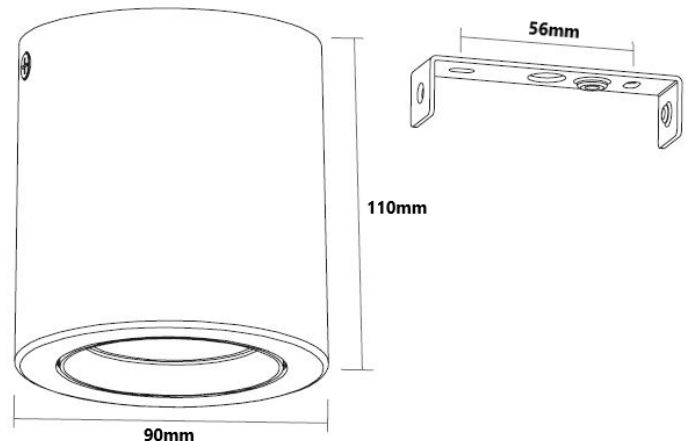

Code	Wattage	Lumen Output	Dimensions	Colour Temperature	Colour
CD10W-NW-B	10W	950LM	90X110mm	4000K	Black
CD10W-NW-W	10W	950LM	90X110mm	4000K	White
CD10W-WW-B	10W	950LM	90x110mm	3000K	Black
CD10W-WW-W	10W	950LM	90X110mm	3000K	White